

Ubiflux Vigor W400

Heat recovery unit



Tested to:

**BS-EN
308:1997**

Standards



77W*

* maximum power per fan

**85%
Efficiency****

** thermal efficiency at maximum flow

➔ Characteristics

- Extremely energy-efficient unit with very high thermal efficiency
- Accurate constant-flow 2.0 - guarantees as much air supply as air extraction
- TFT display touchscreen with well organised menu structure, including easy to use installation and maintenance wizards
- Fully automatic summer bypass fitted as standard
- Intelligent frost protection
- Practical in maintenance and minimal service parts
- Fast upgrade to the “Plus” version
- Compact unit - smallest in its class
- Passivhaus Certified

➔ Modern communication

| | | Basic | Plus |
|--------------------------|--|-------|------|
| 1x RJ12 cable | Control via 4-position switch; RF receiver connection | X | X |
| 1x E-Bus | Connection clock module zone ventilation, Ubiflux Home (app), CO2 sensor or extra pre or post heater | X | X |
| 1x 24v signal output | Programming an error and filter signal | X | X |
| 1x 24v power supply | Connection for CO2 sensors (maximum 4 sensors) | X | X |
| 1x Print connection | Moisture sensor connection | X | X |
| 1x Modbus / Brinkbus | Simple link with building management system; plusprint connection; cascade | X | X |
| 1x (W)LAN | Direct (wireless) connection Ubiflux Home environment (app) | | X |
| 2x analogue input 0-10v | Connection for external sensors (CO2, RH, VOC, I / O module) | | X |
| 2x contact input | Programmable input closed or open contact (9 pre-programmed action options) | | X |
| 2x relay output 0-24v | Connection for geothermal heat exchanger; relay 2 can also be activated at contact input | | X |
| 2x analogue output 0-10v | Connection for geothermal heat exchanger | | X |
| 1x 10K NTC resistance | External temperature sensor connection required for geothermal heat exchanger | | X |

➔ Specifications













| | |
|--|---|
| Ventilation capacity at 200Pa [m³/h] 50-400 | Constant-flow Vane Anemometer (very accurate) |
| Duct connections 4x ø180mm | Condensate Drain ø32 (ball siphon included) |
| Max fan power [W] 2 x 77 | SPI (Specific Power Input) 0,17W/m³/h |
| Dimensions [mm] 4/0 / Dimensions [mm] 2/2 650x750x560 710x750x562 | Weight [kg] 37 |
| Filter Class G4 ISO Coarse 60% | Frost protection Intelligent frost regulation with pre-heater |

➔ Item Numbers









- 100000884004 Ubiflux Vigor W400 4/0 right
- 100000884000 Ubiflux Vigor W400 4/0 left
- 100000884003 Ubiflux Vigor W400 2/2 right
- 100000884002 Ubiflux Vigor W400 2/2 left
- 100000883246 Ubiflux Vigor Plusprint
- 100000883242 Ubiflux Vigor floor mounting stand
- 100000883243 Ubiflux Vigor floor mounting stand + front cover
- 100000888049 Ubiflux Vigor Filter Set IC60% (G4) Pack of 2

➔ Connections

The Ubiflux Vigor is available in a left or right hand version. With the left hand version, the "warm" connections (from home and to home) are connected to the left side of the unit. The condensate drain is then mounted in the right opening under the unit. With the right hand version the "warm" connections (to the home and from the home) are connected to the right side of the unit. This position guarantees better air flow from the fan as well as a positive effect on both efficiency and energy consumption.

| | | Left Version | | Right Version | |
|---|-----------|---|---|---|---|
|  | Fresh air |  |  |  |  |
|  | Outwards | | | | |
|  | Drain | | | | |
|  | Supply |  |  |  |  |
| F | Filter | | | | |

➔ Dimensions & Configurations

| Enter | Left Version | Right Version |
|-------|---|---|
| 1 |  |  |
| | To the Home | To the Home |
| 2 |  |  |
| | To the Outside | To the Outside |
| 3 |  |  |
| | From the Home | From the Home |
| 4 |  |  |
| | From the Outside | From the Outside |
| 5 | Electrical connection | Electrical connection |
| 6 | Condensate Drain (6b) | Condensate Drain (6a) |
| 7 | Extract Filter | Extract Filter |
| 8 | Supply Filter | Supply Filter |
| 9 | Wall Mounting | Wall Mounting |

Left-hand version

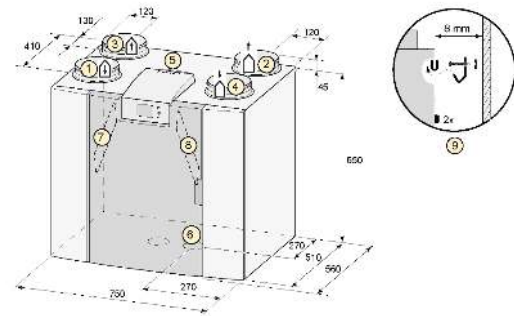

Right-hand version

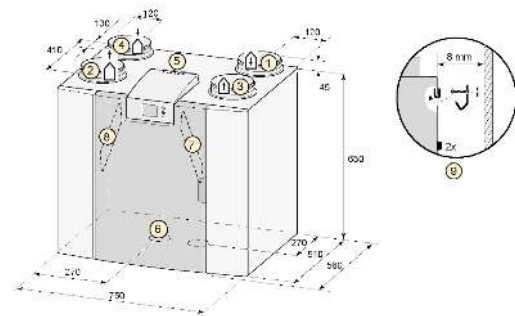

→ Components

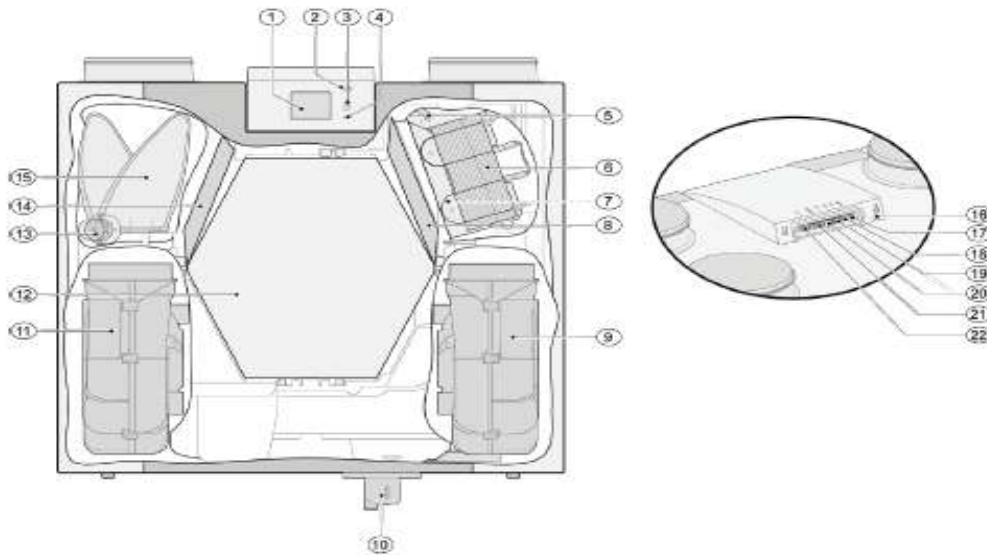

The device shown above is a left-hand version; in the right-hand version, the connection of the pre-heater, bypass valve and the siphon are mirror-mounted.

| | | | | | |
|---|------------------------------|----|---------------------|----|----------------------------------|
| 1 | Touchscreen | 9 | Extract fan | 17 | Relay output (x19) |
| 2 | USB connection (x13) | 10 | Siphon Connection | 18 | 24 volt connection (x18) |
| 3 | Service connection point | 11 | Supply fan | 19 | E-bus connection (x17) |
| 4 | LED indication | 12 | Heat exchanger | 20 | 24 volt connection (x16) |
| 5 | Maximum protection preheater | 13 | Motor Bypass Valve | 21 | Modbus connection (x15) |
| 6 | Preheater | 14 | Supply filter | 22 | Connection position switch (x14) |
| 7 | Temperature sensor | 15 | Bypass Valve | | |
| 8 | Extract filter | 16 | 230 volt power cord | | |

→ Fan Chart

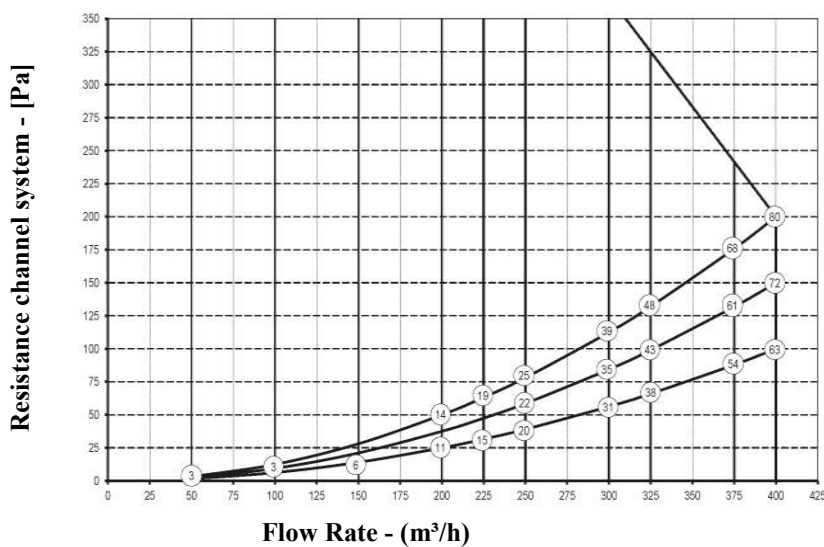

Please note:

The value stated in the circle is the power (watts) per fan.

The device is limited to 200Pa to guarantee a minimum sound quality.

➔ **Sound power**

| | Q [m³/h] | P [Pa] | f [Hz]: Filter | 63 LW [dB] | 125 LW [dB] | 250 LW [dB] | 500 LW [dB] | 1000 LW [dB] | 2000 LW [dB] | 4000 LW [dB] | 8000 LW [dB] | Total LW [dB] | Total weigh ed LWA [dB] |
|-----------------------------------|-----------------------|-------------------|-------------------|------------------|-------------------|-------------------|-------------------|--------------------|--------------------|--------------------|--------------------|---------------------|-------------------------------------|
| Including final correction | To Home | | | | | | | | | | | | |
| | 100 | 25 | ISO Coarse 60% | 63.2 | 50.8 | 47.5 | 42.9 | 36.4 | 24.8 | 15.7 | 18.2 | 63.5 | 44.5 |
| | 150 | 25 | ISO Coarse 60% | 65.8 | 58.8 | 51.3 | 47.8 | 42 | 33.5 | 21.9 | 20.3 | 66.8 | 50 |
| | 150 | 50 | ISO Coarse 60% | 61.9 | 55.1 | 52.8 | 49.7 | 43.9 | 36.5 | 25.1 | 25.5 | 63.4 | 50.5 |
| | 200 | 100 | ISO Coarse 60% | 65.1 | 59.7 | 58.7 | 55.6 | 50.5 | 45 | 35.9 | 23.6 | 67.3 | 57 |
| | 250 | 50 | ISO Coarse 60% | 65.6 | 58 | 61.5 | 56.5 | 51.6 | 47.2 | 38.7 | 25 | 68 | 58 |
| | 250 | 100 | ISO Coarse 60% | 66.5 | 60.2 | 66.2 | 57.4 | 53.1 | 48.6 | 40.3 | 27.5 | 70.2 | 60.5 |
| | 350 | 100 | ISO Coarse 60% | 69 | 65 | 74.7 | 62.5 | 58.1 | 55.6 | 49.2 | 38.1 | 76.5 | 69.5 |
| | 400 | 150 | ISO Coarse 60% | 71.7 | 67.6 | 75.5 | 71.7 | 61.2 | 59.1 | 53.4 | 43.2 | 78.6 | 72 |
| | From Home | | | | | | | | | | | | |
| | 100 | 25 | ISO Coarse 60% | 53.8 | 48 | 41.5 | 29.2 | 16.9 | 10.6 | 11.2 | 17 | 55 | 36 |
| | 150 | 25 | ISO Coarse 60% | 61 | 56 | 48.6 | 39.1 | 24 | 18.8 | 10.7 | 18 | 62.4 | 43.5 |
| | 150 | 50 | ISO Coarse 60% | 59.3 | 55.6 | 48.5 | 38.7 | 25.4 | 21.3 | 11.7 | 17.4 | 61.1 | 43.5 |
| | 200 | 100 | ISO Coarse 60% | 59.7 | 57.1 | 51.2 | 39 | 31.1 | 29.3 | 18.1 | 16.6 | 62 | 45 |
| | 250 | 50 | ISO Coarse 60% | 55.4 | 56.6 | 55 | 38.8 | 31.4 | 30.9 | 19.4 | 16.5 | 60.5 | 46.5 |
| | 250 | 100 | ISO Coarse 60% | 55.4 | 57.6 | 55.1 | 40.6 | 33.3 | 32.6 | 21.8 | 16.7 | 61 | 48 |
| | 350 | 100 | ISO Coarse 60% | 61.3 | 60 | 56.4 | 44.4 | 38.1 | 39 | 29.1 | 18.5 | 64.5 | 51 |
| | 325 | 150 | ISO Coarse 60% | 62.9 | 65.3 | 62.6 | 57.8 | 41.3 | 42.5 | 33.1 | 21.1 | 68.9 | 58 |
| | To the Outside | | | | | | | | | | | | |
| | 400 | 150 | ISO Coarse 60% | 71.8 | 68 | 74.4 | 67.8 | 61 | 58.6 | 52.5 | 42.7 | 77.6 | 70.5 |
| From the Outside | | | | | | | | | | | | | |
| 400 | 150 | ISO Coarse 60% | 62.7 | 64.3 | 62.2 | 54.3 | 43.7 | 42.7 | 32.9 | 22.5 | 68.1 | 57 | |

| | Q [m³/h] | P [Pa] | f [Hz]: Filter | 63 LW [dB] | 125 LW [dB] | 250 LW [dB] | 500 LW [dB] | 1000 LW [dB] | 2000 LW [dB] | 4000 LW [dB] | 8000 LW [dB] | Total LW [dB] | Total weighed LWA [dB] |
|-------------------------|-------------|-----------|-------------------|------------------|-------------------|-------------------|-------------------|--------------------|--------------------|--------------------|--------------------|---------------------|---------------------------------|
| Casing Radiation | 100 | 25 | ISO Coarse 60% | 32.5 | 33.1 | 35 | 26.7 | 18.9 | 12.9 | 3.1 | 6.5 | 38.8 | 29 |
| | 150 | 25 | ISO Coarse 60% | 38.5 | 42.7 | 41.5 | 36 | 27.1 | 21.2 | 10.9 | 14.4 | 46.5 | 37 |
| | 150 | 50 | ISO Coarse 60% | 43.6 | 41 | 39.7 | 32.8 | 26.6 | 23.5 | 10.8 | 7.4 | 46.8 | 35.5 |
| | 200 | 100 | ISO Coarse 60% | 44.5 | 45.2 | 47 | 38.7 | 32.9 | 31.3 | 27.8 | 14.1 | 50.9 | 41.5 |
| | 250 | 50 | ISO Coarse 60% | 42 | 42.4 | 50.9 | 38.8 | 33.1 | 32.8 | 25.5 | 29.3 | 52.3 | 43.5 |
| | 250 | 100 | ISO Coarse 60% | 43.4 | 43.9 | 56.6 | 40.6 | 35 | 34.3 | 24.9 | 20.8 | 57.2 | 49 |
| | 300 | 100 | ISO Coarse 60% | 44.6 | 46.4 | 54.4 | 42.6 | 37.4 | 37.7 | 29.7 | 29.8 | 55.8 | 48 |
| | 350 | 100 | ISO Coarse 60% | 46.5 | 48.2 | 57.6 | 45.8 | 39.8 | 41.1 | 33 | 27.3 | 58.7 | 52 |
| | 400 | 150 | ISO Coarse 60% | 47.2 | 52.1 | 62.8 | 54.3 | 43.2 | 44.5 | 37.4 | 31.9 | 63.9 | 57.5 |



Ubiflux Vigor

Pure power!