

Heating

Cooling

Fresh Air

Clean Air





Foreword



Read this document carefully before use.

With this document you can install, commission and perform the maintenance of the ComfoAir Q in a safe and optimal manner. In this document the ComfoAir Q will be referred to as “the unit”. The unit is subject to continuous development and improvement. Thus the unit may be slightly different from the given descriptions.

The following pictograms are used in the Zehnder documents:

Symbol	Meaning
	Point of interest.
	Risk of compromised performance or damage of the ventilation system.
	Risk of personal injury.

Information found in the user manual

General information about the ventilation system.

Warranty and liability conditions.

EEC declaration of conformity.

How to replace the filters in the unit.

How to clean the valves and/or grilles in the ventilation system.

How to use the display on the unit.



Questions

Speak to your supplier when you have any questions or would like to order a new document or new filters. The contact details of the main supplier are:

Zehnder Group UK Ltd
Unit 4 Watchmoor Point • Camberley, Surrey • GU15 3AD
T +44 (0) 01276 605800 • F +44 (0) 1276 605801
info@zehnder.co.uk • www.zehnderpassivehouse.co.uk

All rights reserved.

This documentation has been made with the utmost care. The publisher cannot be held liable for any damage caused as a result of missing or incorrect information in this document. In case of disputes the English version of the instructions will be binding.

Table of Contents

	Foreword.....	2
1	Safety instructions	5
2	Installation conditions.....	5
3	Transport and unpacking.....	5
4	Technical specifications	6
	4.1 ComfoAir Q 350	6
	4.2 ComfoAir Q 450	7
	4.3 ComfoAir Q 600	7
	4.4 Unit configuration	8
	4.5 Dimension sketch	9
	4.6 Service parts	10
	4.7 Wiring diagram main board.....	11
	4.8 Wiring diagram option box (optional)	12
5	Installation procedures	13
	5.1 Installation on the wall	13
	5.2 Installation on the floor.....	14
	5.3 Installation of the condensation drain	15
	5.5 Installation of the air ducts.....	16
	5.6 Installation of the valves and/or grilles	17
6	Commissioning procedures.....	18
7	Operation.....	19
	7.1 Overview of the display.....	19
	7.2 How to use the display on the unit	19
	7.2.1 How to navigate through the menu	19
	7.2.2 How to access the installer settings.....	19
	7.2.3 How to change the operation mode of the unit	19
	7.2.4 How to reset errors.....	19
	7.3 Menu structure INSTALLER SETTINGS	20
	7.3.1 COMMISSIONING.....	20
	7.3.2 MAIN BOARD SETTINGS.....	21
	7.3.3 OPTION BOX SETTINGS ³	22
	7.3.4 LOG OUT	23
	7.3.5 RESET	23

³ This menu is only visible when the accessory is connected to the unit.

8	Maintenance procedures.....	24
8.1	Procedure for opening the unit	24
8.2	Maintenance of the casing	25
8.3	Maintenance of the heat exchanger	25
8.4	Maintenance of the fans.....	26
8.5	Maintenance of the modulating by-pass valves	27
8.6	Maintenance of the pre-heater.....	27
8.7	Maintenance of the condensation drain.....	28
8.8	Maintenance of the air ducts	28
8.9	Procedure for ending the maintenance.....	29
9.	Malfunction procedures	30
9.1	How to gain access to the ComfoNet connectors on the unit.....	30
9.2	How to gain access to the control PCB.....	30
9.3	How to gain access to the main power fuse of the unit	31
9.4	How to change the location of the pre-heater	31
9.5	How to gain access to the top-section sensor.....	32
9.6	How to remove the modulating by-pass valve	32
9.7	How to gain access to the mid-section sensor.....	33
9.8	Malfunction alerts on the display of the unit.....	34
9.9	Malfunction alerts on the ComfoSense C	35
9.10	Malfunction alerts on the ComfoSwitch C.....	35
9.12	Malfunction alerts on the Control App	35
9.12	Malfunction alerts on the Timer RF.....	35
9.14	What to do in the event of a malfunction alert (troubleshooting).....	36
9.15	What to do in the event of a malfunction (or problem) without a malfunction alert (troubleshooting).....	45
10	Available operating devices	47
11	Optional ancillaries.....	48
	Quick Installation Guide.....	52

1 Safety instructions

- Always obey the safety regulations, warnings, comments and instructions given in this document. When the safety regulations, warnings, comments and instructions in this document are not obeyed personal injury or damage to the unit can occur;
- Always obey the general and locally applicable construction, safety and installation instructions of the local council, electricity and water boards or other agencies;
- Always disconnect the power supply of the unit before you start working on the ventilation system. The unit can cause personal injury when it is open while running. Make sure the unit cannot switch back on by accident;
- Always connect air ducts of at least 900mm to the unit before you connect the power to the unit. This ensures the motor cannot be touched while the unit is active;
- After installation all parts that can cause personal injury are secured behind the casing. Tools are required to open the casing;
- The installation, commissioning and maintenance must be carried out by a certified engineer unless instructed differently. A non-certified engineer can cause personal injury or damage the performance of the ventilation system;
- Do not modify the unit or the specifications given in this document. A modification can cause personal injury or damage the performance of the ventilation system;
- Always take ESD-inhibiting measures when dealing with electronics, such as wearing an antistatic wristband. The electronics can be damaged by static charges;
- Install the unit on a 230V~ 50Hz mains connection. Any other power connection will damage the unit;
- The unit is designed for residential use. The unit is not made for industrial use, such as swimming pools or saunas. Installation in an industrial environment can damage the unit;
- Ensure this document is left with the unit after use.

2 Installation conditions

- Check if the installation area is frost-free;
- Zehnder does not recommend you to install the unit in areas with a higher than average humidity (such as bathroom or w.c.). This will prevent condensation on the outside of the unit;
- The permissible temperature of the air to be moved ranges between -20°C to +60°C;
- Check if the electrical installation is suitable for the maximum power of the unit. You can find the maximum power values in the chapter “Technical specifications”.
- Check if the electrical installation is suitable for

the maximum power of the option box. You can find the technical specifications of the option box in the chapter “Wiring diagram option box”.

- Check if the installation area of the unit has sufficient room for the next aspects:
 - The air duct system around the unit;
 - Carrying out maintenance activities in front of the unit (at least 1m);
 - The condensation drain below the unit (optional);
 - The wiring of an external wired controller (optional);
 - The electrical power connection of the unit.

3 Transport and unpacking



The permissible storage and transport temperature ranges between -40°C to +60°C. Transport and unpack the unit with care. Discard the packing material in an environmentally friendly manner.

Checking the delivery

Speak to your supplier immediately in case of damage or an incomplete delivery. The delivery should at least include:

- The unit: check the identification plate to ensure that it is the correct type;
- Mounting bracket;
- Power cord;
- Documentation;
- Unit with standard heat exchanger:
 - Condensation drain adapter 32mm tube;
 - Condensation drain adapter 1¼” thread tube;
 - Condensation drain sealing cap.
- Unit with enthalpy exchanger:
 - 2 condensation drain sealing caps.

Information found on the identification plate	
Suffix	Meaning
ComfoAir	Product family name.
Q	Product type name.
350	Maximum air volume of 350 m ³ /h.
450	Maximum air volume of 450 m ³ /h.
600	Maximum air volume of 600 m ³ /h.
GB	Country code of the unit.
R	The unit has been set with the supply and extract air to the right side as default.
L	The unit has been set with the supply and extract air to the left side as default.
ST	The unit has four fixed air connections.
PH	The unit has a pre-heater installed as default.
ERV	The unit has an enthalpy exchanger installed as default.

4 Technical specifications

	Q 350		Q 450		Q 600	
Performance						
Maximal airflow	350m ³ /h		450m ³ /h		600m ³ /h	
Thermal Yield ¹	92%		90%		89%	
Electrical data						
Maximal power ² including pre-heater	1850W	10.00A	2240W	10.80A	2620W	12.70A
Maximal power ² excluding pre-heater	180W	1.42A	250W	1.98A	350W	2.77A
Power Supply	230V±10%, single phase, 50Hz					
Cos φ	0.36 - 0.54		0,32 - 0.57		0.4 - 0.62	
Connection data						
Air connection shape	Round					
Air connection size (Ø)	Inside: 160mm Outside: 190mm		Inside: 180mm Outside: 200mm		Inside: 180mm Outside: 200mm	
Condensation drain connection	Tube / thread connection					
Condensation drain size (Ø)	32mm / 1¼"					
ComfoNet data						
Maximal power	400mA@12V					
Maximal non powered devices	4					
Cable type	2x unshielded twisted pair, stiff (solid) wires 0,6mm ² (max 50m)					
Material specifications						
Housing	Coated Sheet Steel					
Interior	EPP and ABS					
Heat Exchanger	Polystyrene					
Enthalpy Exchanger	Polyethylene-polyether-copolymer					
General						
IP classification	IP40					
ISO classification	B					
Weight	50kg					
Filter class	Outdoor air: G4 / F7 ¹⁵ Extract air: G4					

4.1 ComfoAir Q 350

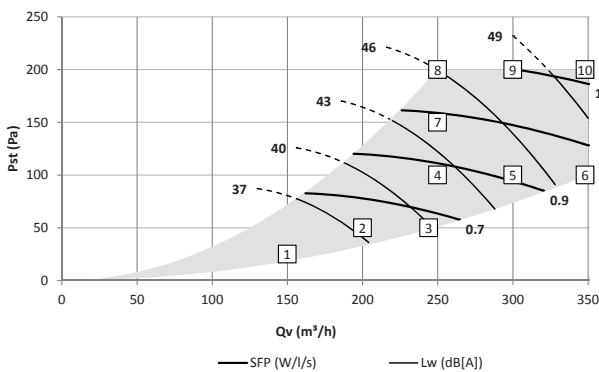

Lw in dB(A) reference 10⁻¹²W
 Casing radiation measured according to ISO 3741:2010
 Supply noise and extract noise measured according ISO 5135:1997
 (values include end duct correction)
 SFP in Wh/m³ calculated using data measured according EN13141-7:2010
 cos phi with pre heater switched off (if present)
¹ According to EN 13141-7:2010.
² At -15°C and max airflow.
¹⁵ Standard available on the PH unit.

	Qv m ³ /h	Pst Pa	P W	cos φ	SFP Wh/l/s	Lw, supply dB(A)	Lw, extract dB(A)	Lw, casing dB(A)
1	150	25	16	0.41	0.37	46	34	33
2	200	50	31	0.45	0.57	51	38	37
3	245	50	43	0.47	0.64	54	40	40
4	250	100	59	0.49	0.85	56	42	42
5	300	100	77	0.50	0.92	59	45	45
6	350	100	98	0.51	1.00	63	48	47
7	250	150	74	0.50	1.06	59	44	44
8	250	200	88	0.51	1.27	61	46	46
9	300	200	108	0.52	1.30	63	48	48
10	350	200	131	0.53	1.35	66	50	50

4.2 ComfoAir Q 450

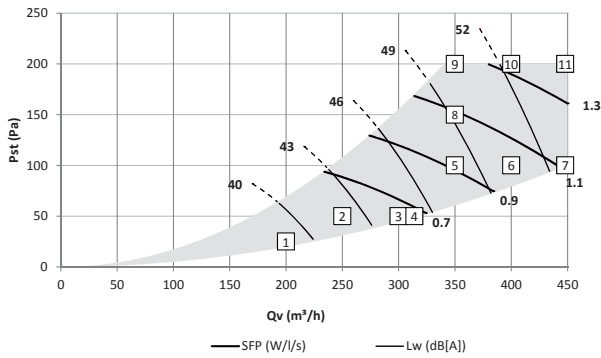

	Qv m³/h	Pst Pa	P W	cos φ -	SFP Wh/l/s	Lw, supply dB(A)	Lw, extract dB(A)	Lw, casing dB(A)
1	200	25	19	0.40	0.33	51	40	39
2	250	50	37	0.46	0.54	54	43	42
3	300	50	53	0.48	0.64	57	45	44
4	315	50	59	0.49	0.67	57	46	45
5	350	100	89	0.52	0.92	61	48	48
6	400	100	113	0.54	1.01	63	50	50
7	450	100	140	0.55	1.12	66	52	53
8	350	150	106	0.53	1.09	62	49	49
9	350	200	122	0.54	1.26	63	50	50
10	400	200	148	0.55	1.33	65	52	52
11	450	200	177	0.57	1.42	68	54	54

4.3 ComfoAir Q 600

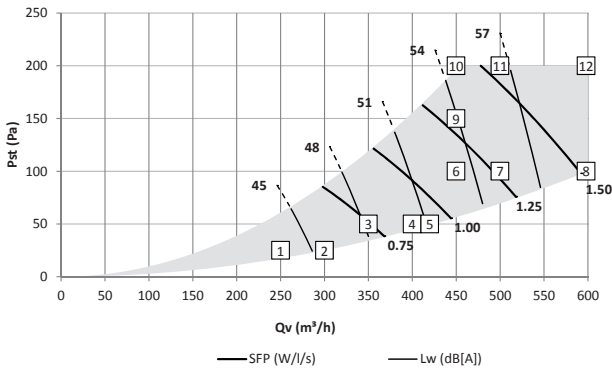

	Qv m³/h	Pst Pa	P W	cos φ -	SFP Wh/l/s	Lw, supply dB(A)	Lw, extract dB(A)	Lw, casing dB(A)
1	250	25	28	0.48	0.40	54	43	43
2	300	25	44	0.51	0.53	56	45	45
3	350	50	72	0.54	0.74	59	48	48
4	400	50	97	0.55	0.87	62	50	50
5	420	50	107	0.56	0.92	63	51	51
6	450	100	143	0.57	1.15	65	53	53
7	500	100	176	0.59	1.27	68	55	55
8	600	100	254	0.61	1.53	73	59	60
9	450	150	162	0.58	1.29	66	53	54
10	450	200	180	0.59	1.44	67	54	55
11	500	200	215	0.60	1.55	70	56	57
12	600	200	296	0.61	1.77	75	60	61

Lw in dB(A) reference 10⁻¹²W

Casing radiation measured according to ISO 3741:2010

Supply noise and extract noise measured according ISO 5135:1997 (values include end duct correction)

SFP in Wh/m³ calculated using data measured according EN13141-7:2010

cos phi with pre heater switched off (if present)

4.4 Unit configuration

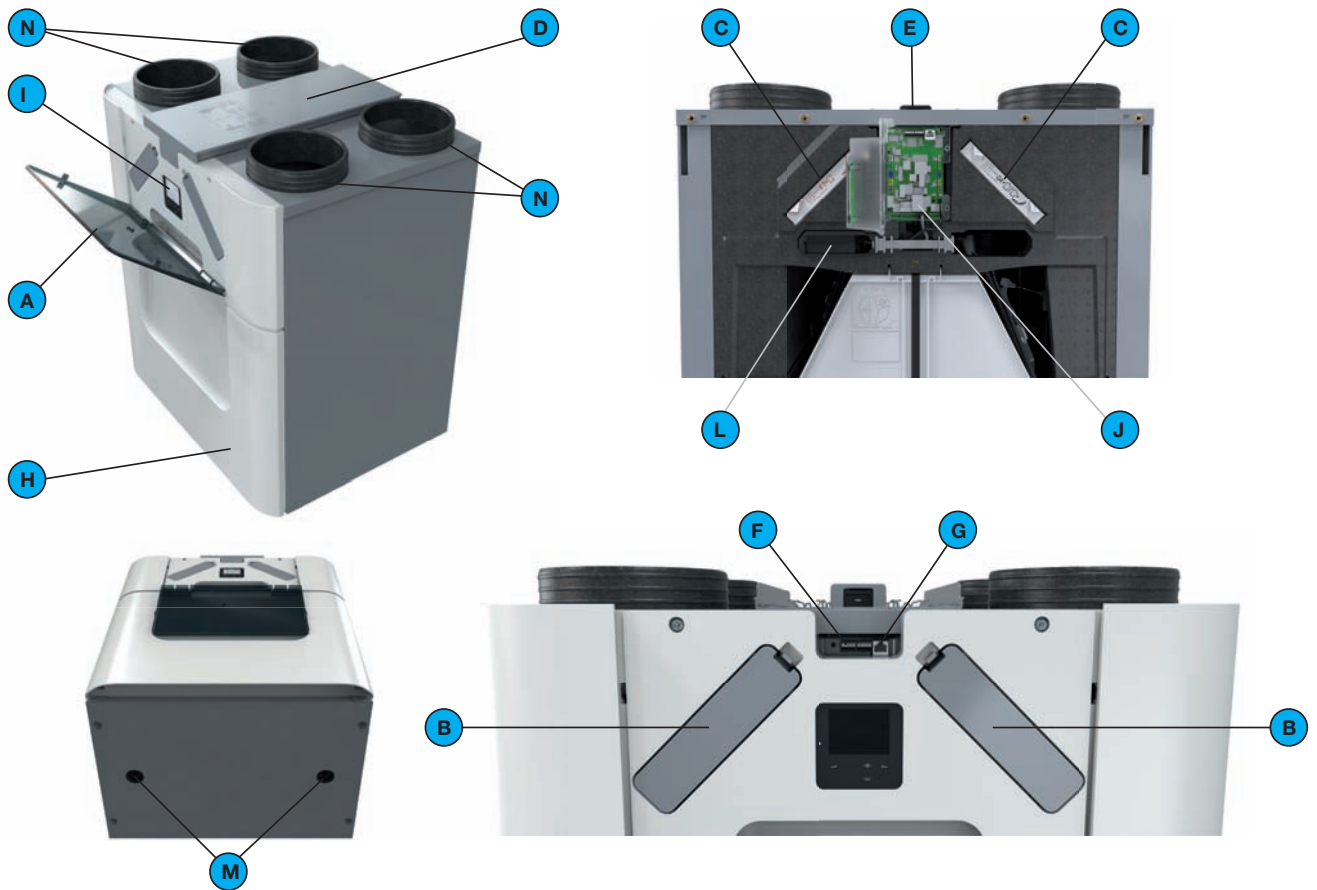

Position	Part
A	Semi-transparent visor for access to the display and the filter caps.
B	2 filter caps for easy access to the filters.
C	2 filters for air purification.
D	Cable tray cover for cover and protection of the connected cables.
E	Identification plate detailing information on the unit (not visible).
F	2 ComfoNet plug-in connections.
G	ComfoNet RJ45 connection.
H	Front cover for an air tight seal.
I	Display behind a display cover to operate the unit.
J	Main board behind the display cover.
L	Pre-heater for frost protection. (optional; standard in unit version "PH")
M	2 condensation drains to drain the condensation of the warm extract air.
N	4 connections for the air ducts.

4.5 Dimension sketch

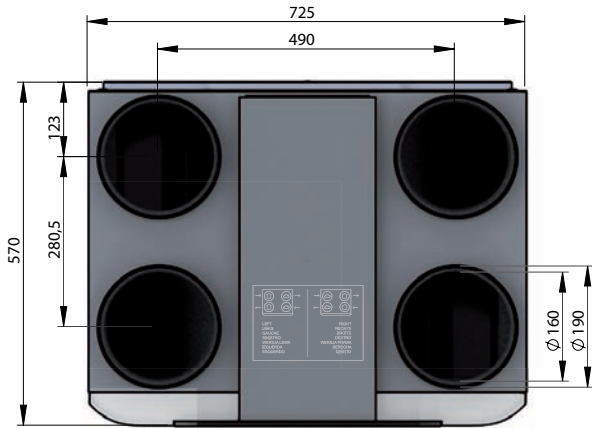

ComfoAir Q 350

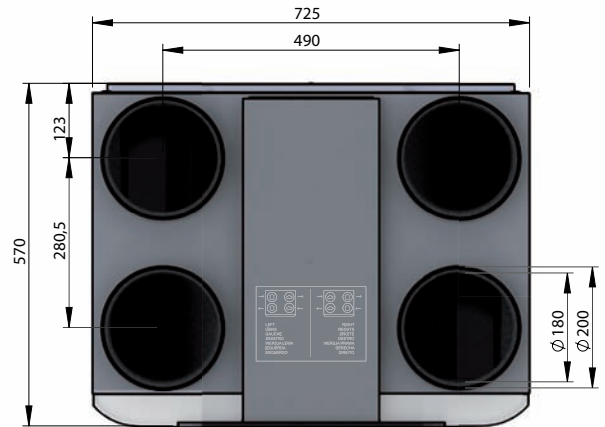

ComfoAir Q 450 / ComfoAir Q 600

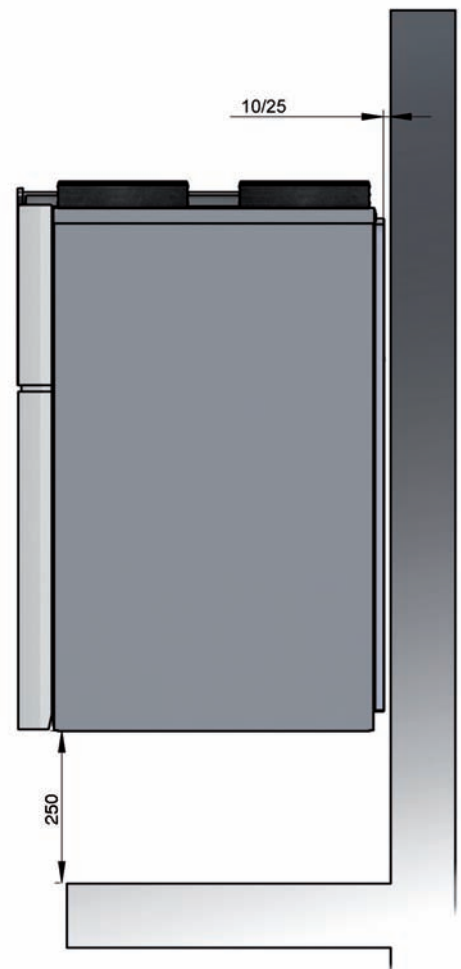
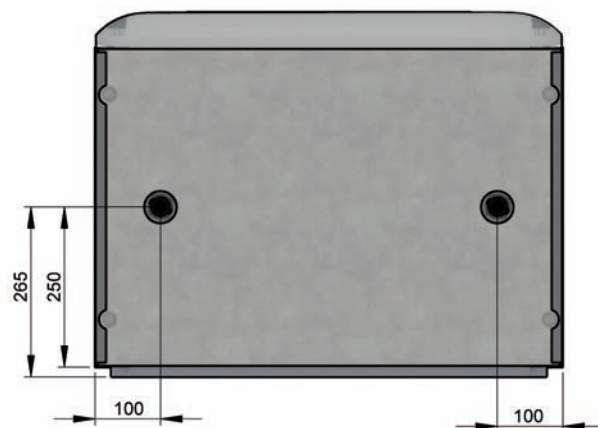
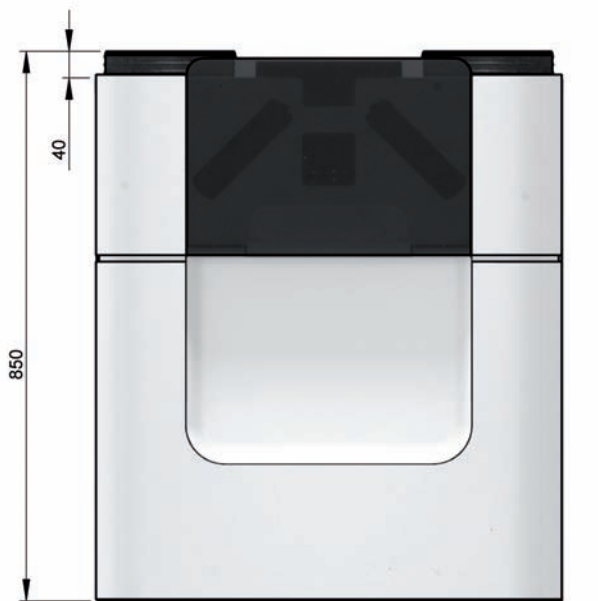

4.6 Service parts

The service parts mentioned below can be ordered as a special service set from Zehnder. Each set will be supplied with its own service instruction explaining how to replace the part. Please check the pricelist of the supplier for the article codes and prices of all available sets.

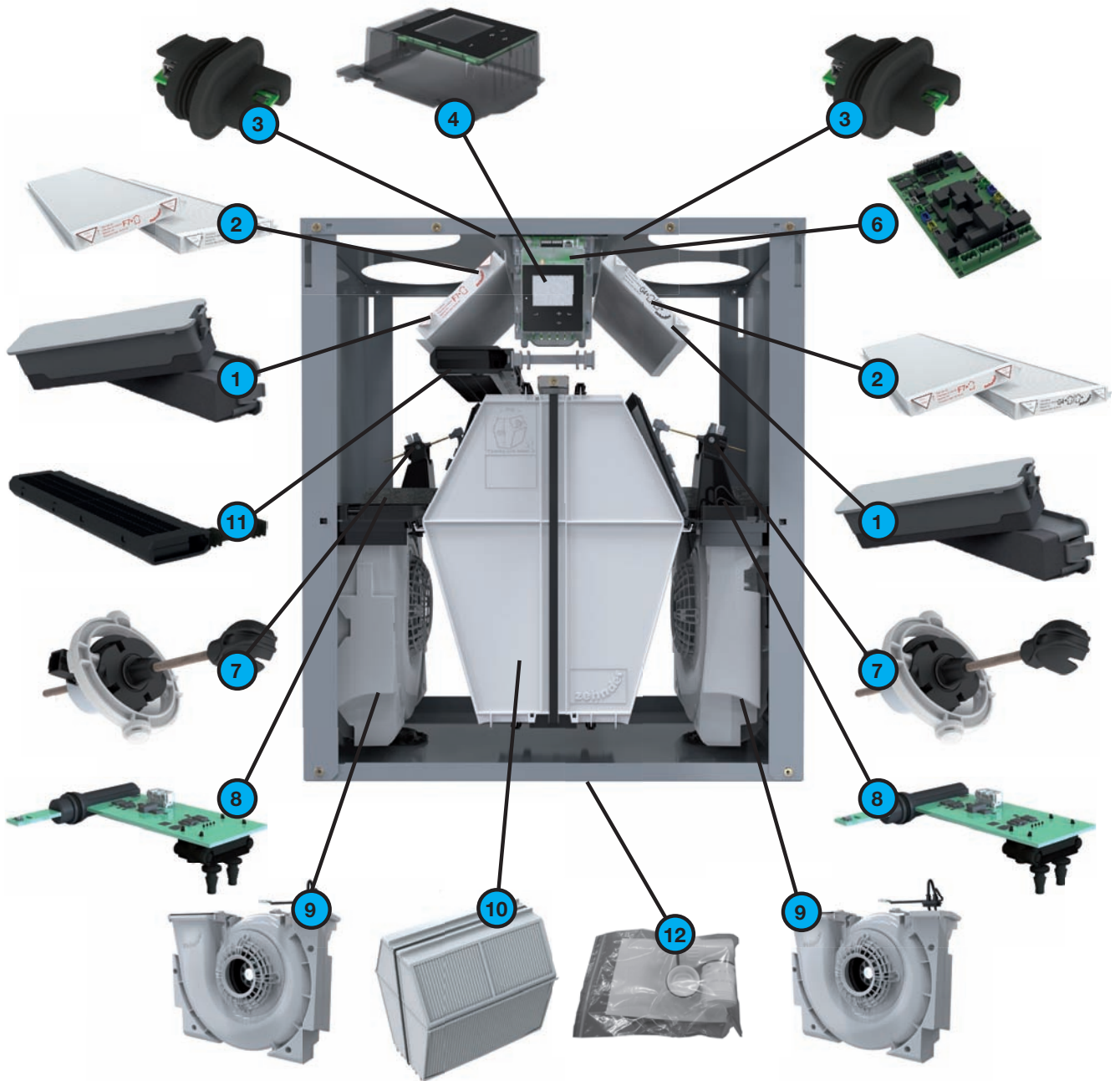

Position	Part
1	Filter cap set (2x)
2	Filter set G4/G4 (1x/1x) Filter set G4/F7 ¹⁵ (1x/1x)
3	Top-section sensor
4	Display
6	Main board
7	Modulating by-pass actuator
8	Mid-section sensor
9	Fan
10	Heat exchanger Enthalpy exchanger
11	Pre-heater
12	Drain set

¹⁵ Standard available on the PH unit.

4.7 Wiring diagram main board

Legend:

Code	Meaning	Meaning		
		Orientation: Right	Orientation: Left	
PE	Green / Yellow	DISPLAY	Display screen	Display screen
N / BU	Blue	RF	Not applicable	Not applicable
L / BK	Brown or Black	VV	Pre-heater	Pre-heater
WH	White	BYP	Modulating by-pass actuator	Modulating by-pass actuator
RD	Red	M1	Exhaust motor	Supply motor
GN	Green	M2	Supply motor	Exhaust motor
YE	Yellow	S1	Sensor outdoor air	Sensor extract air
GY	Grey	S2	Exhaust air pressure sensor	Supply air pressure sensor
VT	Violet	S3	Sensor supply air	Sensor exhaust air
17 / 18	ComfoNet plug-in	S11	Sensor extract air	Sensor outdoor air
19	Not applicable	S22	Supply air pressure sensor	Exhaust air pressure sensor
		S33	Sensor exhaust air	Sensor supply air

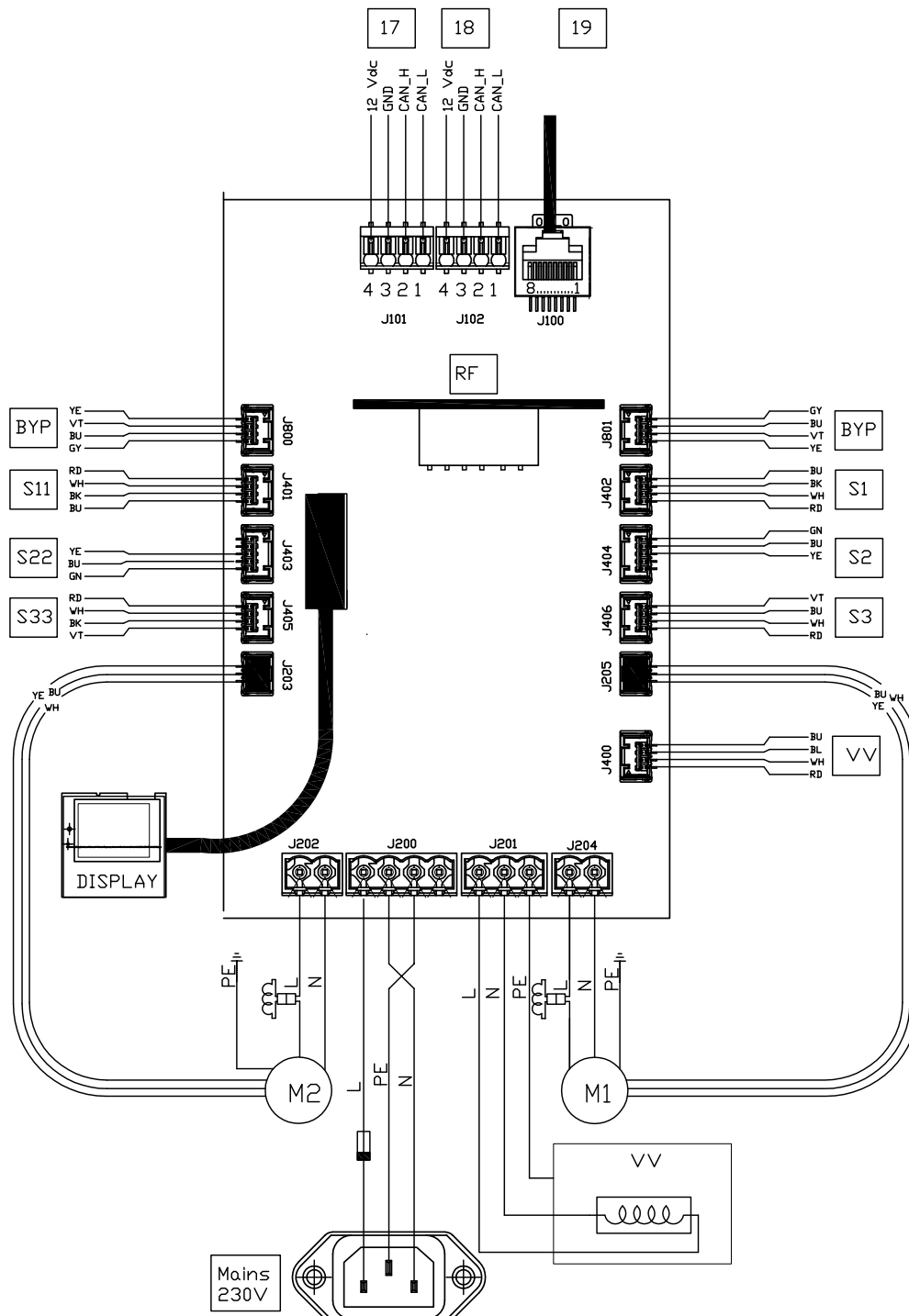





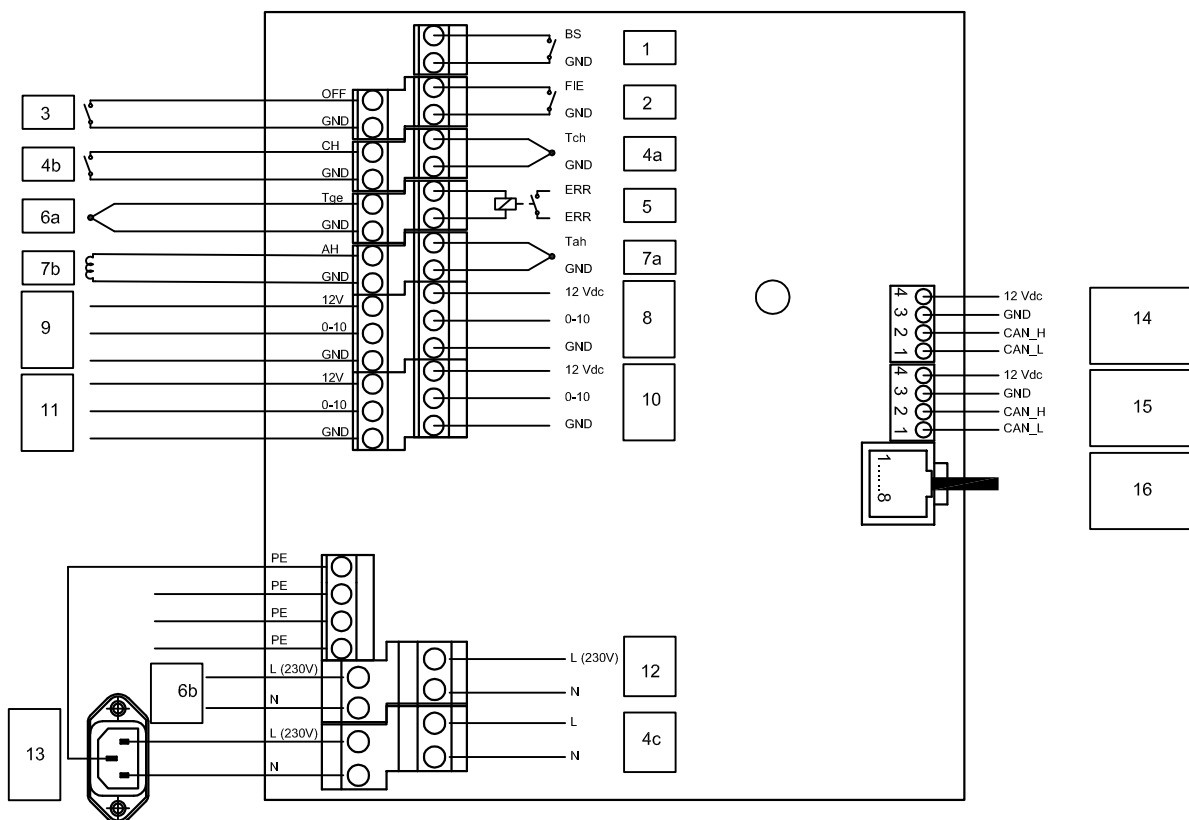





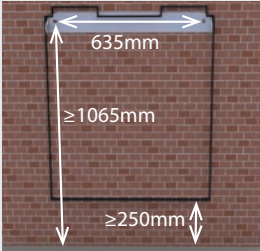

4.8 Wiring diagram option box (optional)

Code	Meaning	Technical specifications			
		Interface	U _{max}	I _{max}	L _{max-wiring}
1	Bathroom switch	Digital	3.3Vdc	1mA	30m
2	External filter error sensor	Digital	3.3Vdc	1mA	30m
3	Standby switch	Digital	3.3Vdc	1mA	30m
4a	Not applicable	Analog	3.3Vdc	1mA	30m
4b	Not applicable	Digital	3.3Vdc	1mA	30m
4c	Not applicable	230Vac switched	230Vac	4A	30m
5	Error contact	Potential free contact			30m
6a	ComfoFond-L Q sensor	Analog	3.3Vdc	1mA	30m
6b	ComfoFond-L Q pump	230Vac switched	230Vac	<4A	30m
7a	Post-heater sensor	Analog	3.3Vdc	1mA	30m
7b	Post-heater control	0 - 10Vdc output	10Vdc	10mA	30m
8	0-10V input 3	0 - 10Vdc input	12Vdc	37,5mA	30m
9	0-10V input 1	0 - 10Vdc input	12Vdc	37,5mA	30m
10	0-10V input 4	0 - 10Vdc input	12Vdc	37,5mA	30m
11	0-10V input 2	0 - 10Vdc input	12Vdc	37,5mA	30m
<p>☞ I_{max} of code 8, 9, 10 and 11 together: <150mA</p>					
12	Sub-soil heat exchanger valve	230Vac constant	230Vac	4A	30m
13	Mains power connector	±10%, single phase, 50Hz	230Vac	10A	2m
<p>☞ The mains power is needed to power the 230V functions (code 4c, 6b and 12). All other functions are powered through the ComfoNet. I_{max} of code 4c, 6b and 12 together: 10A</p>					
14	ComfoNet connector	plug-in	12Vdc	37,5mA	30m
15	ComfoNet connector	plug-in	12Vdc	37,5mA	30m
16	ComfoNet connector	RJ45	12Vdc	30m	
<p>☞ I_{max} of the ComfoNet connectors together: <150mA</p>					



5 Installation procedures

5.1 Installation on the wall

	<p>1</p> 	<p>2</p> 
<p>! Install the unit against a wall with a minimum mass of 200 kg/m².</p> <p>The given height is an indication. The selected type of condensation drain and air ducts will determine the exact height.</p>	<p>Attach the mounting bracket to the wall.</p> <ul style="list-style-type: none"> ■ Make sure the openings on the bracket are on the top; ■ Make sure the bracket is level. 	<p>Hang the unit on the mounting bracket fixed to the wall.</p> <ul style="list-style-type: none"> ■ For Zehnder ComfoPipe Plus air ducts: use opening 1; ■ For all other air ducts: use opening 2.
<p>3</p> 	<p>4</p> 	<p>5</p> <p>Example ancillaries</p> 
<p>Open the semi-transparent visor.</p>	<p>Pull the cable tray cover forwards.</p>	<p>Install the necessary ancillaries as instructed in their associated manuals.</p>
<p>6</p> <p>Example siphon</p> 	<p>7</p> <p>Example air duct</p> 	<p>8</p> <p>Example valve Example grille</p> 
<p>Install the siphon to the bottom of the unit as instructed in the installation section of the condensation drain.</p>	<p>Install the air ducts to the unit as instructed in the installation section of the air ducts.</p> <p>! Do not forget to remove the protection covers from the unit before installing the air ducts.</p>	<p>Install the valves and grilles as instructed in the installation section of the valves and grilles.</p>
<p>9</p> 	<p>10</p> 	<p>11</p> 
<p>Connect the power supply of the unit.</p>	<p>Install all parts back in reverse order.</p>	<p>Commission the unit as instructed in the commissioning chapter.</p>

5.2 Installation on the floor

	<p>1 Example of instruction</p> 	<p>2</p> 
<p>Use a Zehnder mounting frame on the floor (available as an optional extra) for walls with a mass of less than 200 kg/m². This will reduce contact noise as much as possible.</p>	<p>Install the mounting frame as instructed in its installation instructions.</p>	<p>Place the unit on the mounting frame. ■ Make sure the unit is locked in place.</p>
<p>3</p> 	<p>4</p> 	<p>5 Example ancillaries</p> 
<p>Open the semi-transparent visor.</p>	<p>Pull the cable tray cover forwards.</p>	<p>Install the necessary ancillaries as instructed in their associated manuals.</p>
<p>6 Example siphon</p> 	<p>7 Example air duct</p> 	<p>8 Example valve Example grille</p> 
<p>Install the siphon to the bottom of the unit as instructed in the installation section of the condensation drain.</p>	<p>Install the air ducts to the unit as instructed in the installation section of the air ducts.</p> <p>! Do not forget to remove the protection covers from the unit before installing the air ducts.</p>	<p>Install the valves and grilles as instructed in the installation section of the valves and grilles.</p>
<p>9</p> 	<p>10</p> 	<p>11</p> 
<p>Connect the power supply of the unit.</p>	<p>Install all parts back in reverse order.</p>	<p>Commission the unit as instructed in the commissioning chapter.</p>

5.3 Installation of the condensation drain

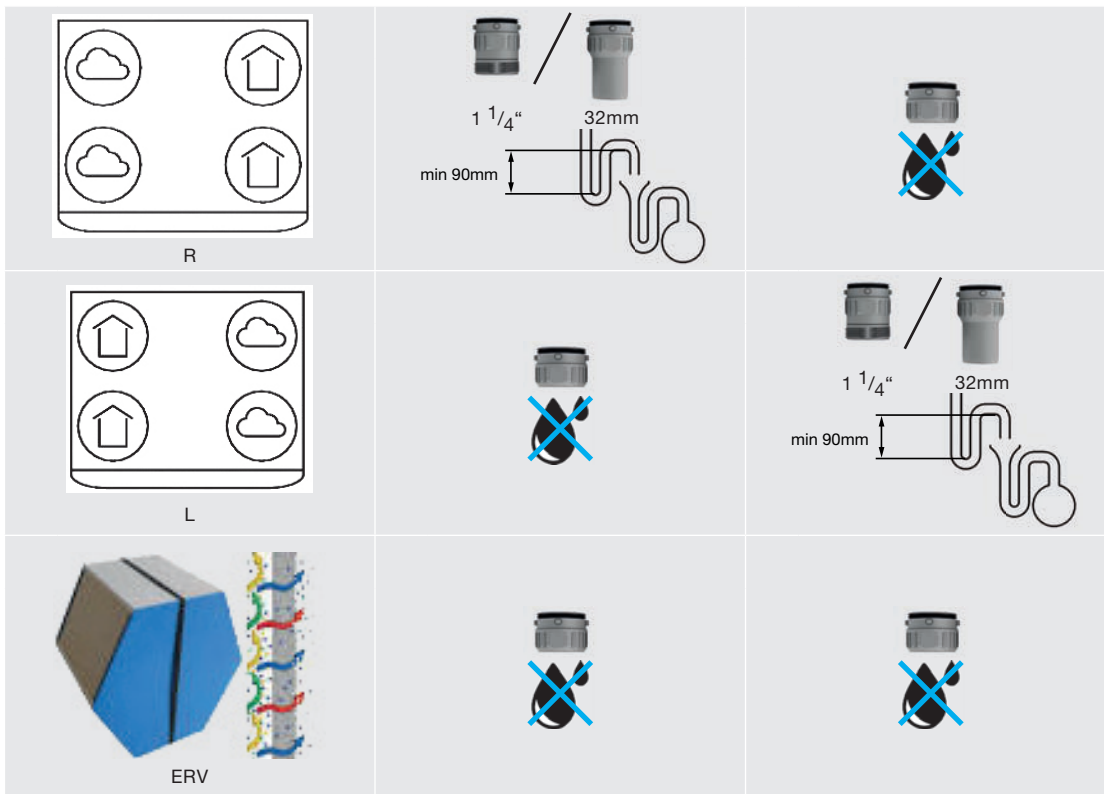

The condensation created by the unit must be drained off frost-free, at a gradient and incorporate an air seal.

To drain the condensation from the unit, two Zehnder bayonet connections are located on the bottom of the unit. These connections are not air tight. Thus it is necessary to close off these connections with the separately delivered sealing cap(s) or with a dry siphon.

! Do not install a water lock (U-bend) on to the unit. On warm days the water will evaporate from the siphon.

Enthalpy exchanger installed

When the unit is fitted with an enthalpy exchanger the humidity from the extracted air is partly transferred to the fresh supply air. In this case there is no condensate that must be drained from the unit. Thus a dry siphon is not necessary with an enthalpy exchanger.

When no dry siphon is installed, seal off both Zehnder bayonet connections with the separately delivered condensation drain sealing caps. The unit is not airtight if these connections are left open.

☞ When desired you can always connect a dry siphon to a Zehnder bayonet connection.

5.5 Installation of the air ducts



The unit can be installed with any standard non flexible air duct system or with a special Zehnder air duct system. When installing a Zehnder air duct system read its installation instructions first. The next aspects must always be kept in mind during the installation of the air ducts:

- ⚠ Always connect air ducts of at least 900mm to the unit before you connect the power to the unit. This ensures the motor cannot be touched while the unit is active.**

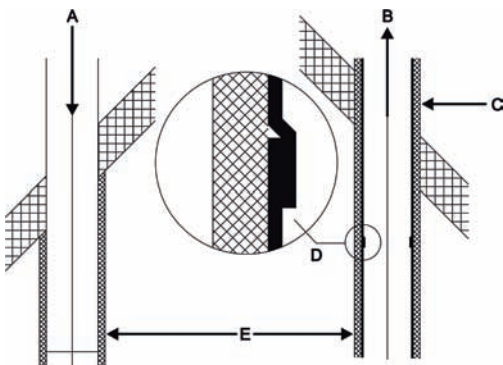

- The distance (E) between the opening of the outdoor air duct (A) and the opening of the exhaust air duct (B) must be at least 1.5 m;
- The position of the outdoor air opening (A) relative to other possible sources of stale air is very important (other exhaust-air outlets, street versus garden, etc.);
- Drain the exhaust duct (D) in the direction of the unit.
- Insulate the outdoor air duct and the exhaust air duct between the roof/wall passage to render the unit damp proof. This prevents the formation of condensation on the outside of the ducts;

- Zehnder recommends that you fit thermal and damp-proof insulation to the supply duct from the unit up to the supply valves and or grilles. This will prevent unnecessary temperature loss in the summer and winter;
- Install the air duct with as little air resistance as possible and free from air leakage;

Size	Minimum air ducts ϕ
350	160mm
450	180mm
600	200mm

- Make sure the inside of the air ducts do not have an obstruction of any sort. Air ducts must not have sharp bends, dents or long screws inside. Obstructions will compromise the performance and maintenance of the system;
- Install a silencer directly onto the supply air and extract air connections and ensure it is straight. For relevant recommendations, please contact Zehnder;
- Do not install a flexible air duct system. These will disturb the basic operating principle of the balanced ventilation system;
- When a semi-rigid air duct system is desired only use a Zehnder approved system. Any other semi-rigid air duct will disturb the basic operating principle of the balanced ventilation system.

Legend

Code	Meaning
ODA	Outdoor air
SUP	Supply air
ETA	Extract air
EHA	Exhaust air
R	Supply and extract air to the right side
L	Supply and extract air to the left side

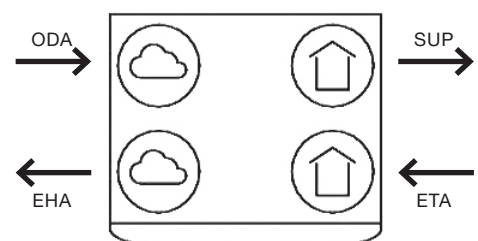

R

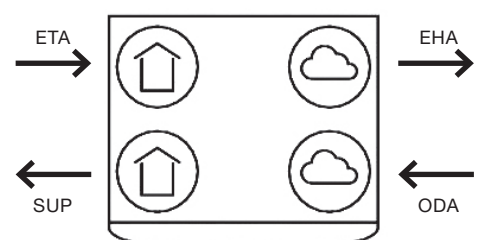

L

5.6 Installation of the valves and/or grilles



Example valve

Example grille







- Install supply and extract valves and/or supply and extract grilles (e.g. in an open living kitchen) at least 1m from each other. This will prevent the supply air short circuiting with the extract air;
- Use clean sector valves when the valves are installed close to the wall. This will keep the walls clean;
- To ensure good transfer of air throughout the dwelling, there should be a grille or gap near the inside doors. The grille or gap must provide an overflow of at least 12 cm² per l/s. This is equivalent to:
 - A gap under the inside doors of minimum area 7600mm² above the floor finish;
 - A gap under the inside doors of at least 10mm for a standard 760mm width door.

 **Do not obstruct these openings. For instance with furniture, draught excluders or deep pile carpet, as the airflow in the house will stagnate.**







- Zehnder recommend that you install the ventilation system with supply and extract valves made by Zehnder.

6 Commissioning procedures

Zehnder recommends cleaning the air ducts before commissioning the unit when the dwelling is being occupied. This will prevent damage to the furniture from building dust blown out of the air ducts.

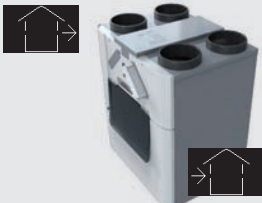
<p>1</p> 	<p>2</p> 	<p>3</p> 
<p>Connect the power to the unit.</p>	<p>Open the semi-transparent visor.</p>	<p>The unit will automatically start up the commissioning wizard. Follow the instructions on the display.</p>
<p>4</p> <p>Example ancillaries</p> 	<p>5</p> 	<p>6</p> <p>Example report</p> 
<p>Commission all connected ancillaries as instructed in their manual.</p> <p> The commission procedure for the RF ancillaries is different from the older Zehnder units.</p>	<p>Set the desired values in the advanced menus. In the user manual you can find how to set the advanced menus.</p>	<p>Fill in the installation/test report in the back of the user manual.</p>

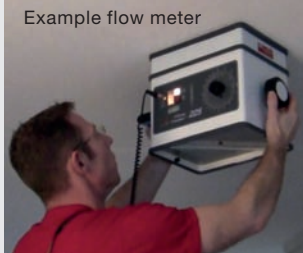
Attention point commissioning wizard

	 <p>Right Left</p>	<p>Example siphon</p> 
<p>You can ask for the required password at Zehnder.</p>	<ul style="list-style-type: none"> ■ Right = The supply and extract air are to the right side of the unit; ■ Left = The supply and extract air are to the left side of the unit. 	<p>When the unit has a standard heat exchanger a dry siphon must always be present.</p>
 <p>Left</p>		<p>Example flow meter</p> 
<p>When the supply and extract air are to the left side of the unit the filter locations are:</p> <ul style="list-style-type: none"> ■  = Left side; ■  = Right side. <p>Make sure the arrow on the filters are pointing upwards.</p> <p>When the supply and extract air filters are the same, there is no need to switch the filters as instructed by the unit.</p>	<p>When opening all valves also open all grilles and close all windows and doors.</p>	<p>Use a flow meter to set the valves and/or grilles into the correct position during fine tuning.</p>

7 Operation

7.1 Overview of the display

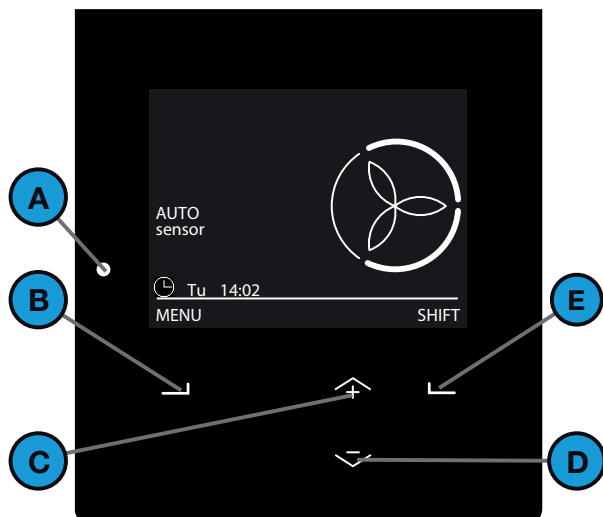

Position	Part
A	Status indicator LED light.
B	Universal button. The function depends on the current text on the display.
C	Up button to: ■ Increase fan speed; ■ Increase value; ■ Select the previous item.
D	Down button to: ■ Decrease fan speed; ■ Decrease value; ■ Select the next item.
E	Universal button. The function depends on the current text on the display.

7.2 How to use the display on the unit

The main screen will start automatically when you open the visor. In case of an error or warning messages the display will also start when the visor is closed. The display will always stop automatically after 15 minutes of no activity. You can find the meaning of the symbols on the display and the LED signals in the user manual.

7.2.1 How to navigate through the menu

1. Select MENU to get access to the menus.
2. Use the up and down button to navigate forward and back through the menus.
3. When the selection arrow is in front of the desired option select CONFIRM.

When you are done with all your operating options:

1. Select BACK until you reach the main screen.
2. Close the visor.

7.2.2 How to access the installer settings

- > MENU > INSTALLER SETTINGS
1. Select SHIFT for at least 4 seconds in the main screen.
 2. Select the password with the up and down button.
 3. Select CONFIRM after each number.

 **You can ask for the required password at Zehnder.**

The symbol  is displayed in the left top corner of the display when the installer password is active.

The unit will automatically deactivate the installer password after 60 minutes. You can also deactivate the installer password in the main screen by following the next steps:

1. Select SHIFT.
2. Select LOG OUT.

Or by accessing > MENU > INSTALLER SETTINGS > LOG OUT.

7.2.3 How to change the operation mode of the unit

> MENU > INSTALLER SETTINGS > MAIN BOARD SETTINGS > SERVICE MODE

1. Navigate to INSTALLER SETTINGS.
2. Navigate to MAIN BOARD SETTINGS.
3. Navigate to SERVICE MODE.
4. Navigate to
 - ACTIVE MODE when you have completed all the maintenance tasks.
 - SERVICE MODE when you want to remove or install the heat exchanger.
5. Select CONFIRM.

7.2.4 How to reset errors

> MENU > RESET ERROR

1. Navigate to RESET ERROR.
2. Select CONFIRM.
3. Wait for 5 minutes.

 **You can only reset an error when the unit is in active mode.**

7.3 Menu structure INSTALLER SETTINGS

The installer settings menus are only visible when the installer password is active. In the chapter “How to access the installer settings” you can find how to activate the installer password.

You can find the explanation of all other menus, e.g. the advanced menu, in the user manual. Please help the user by also setting the advanced user menus for them. Like for instance the settings for the control of the sensors and temperature comfort.

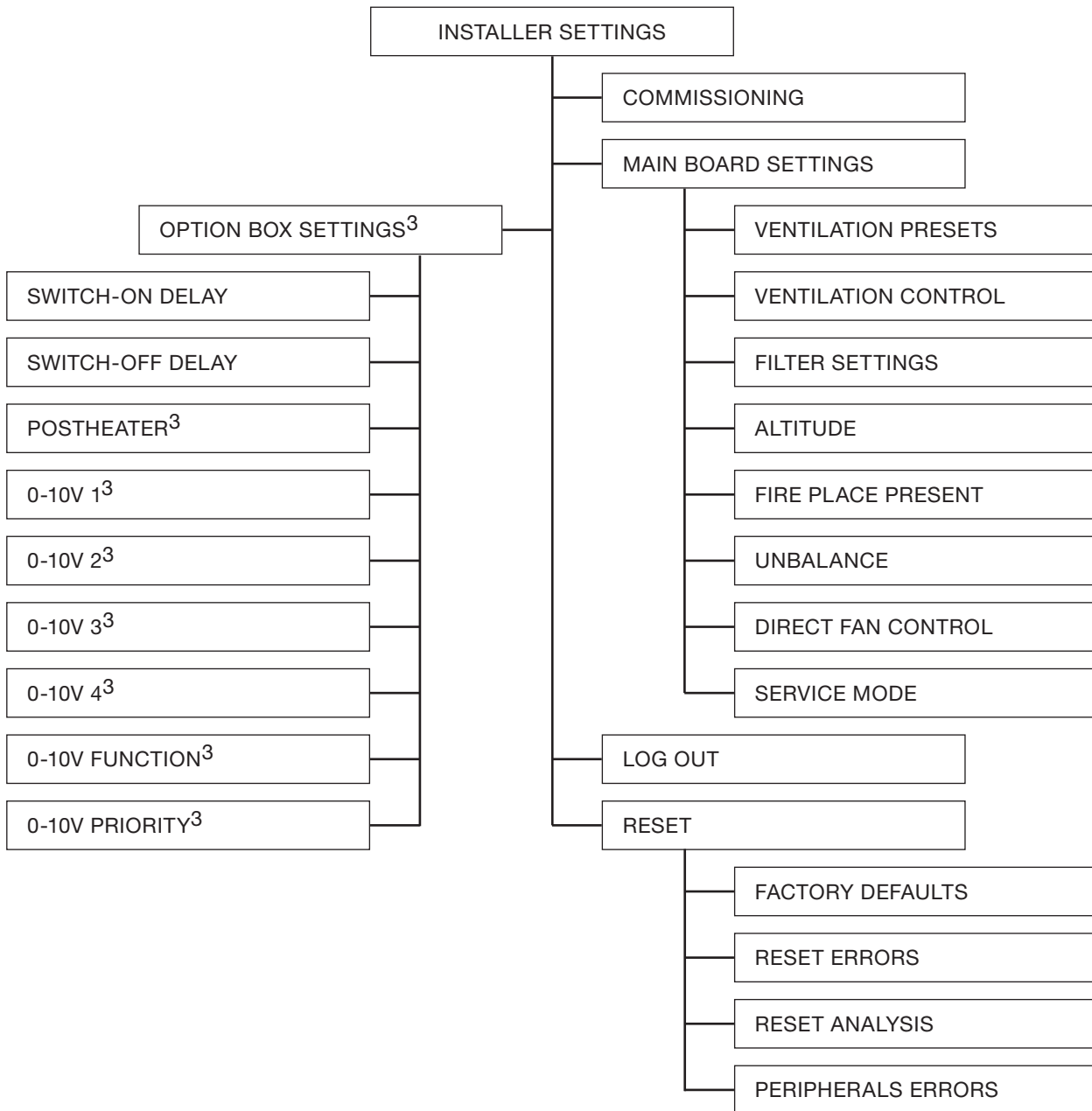

7.3.1 COMMISSIONING

> MENU > INSTALLER SETTINGS > COMMISSIONING

Menu item	Function
START	To start the commissioning wizard. In the chapter “Commissioning procedures” you can find attention points for the commissioning wizard. When the unit has never been commissioned the commissioning wizard will automatically start up as soon as the power from the unit is switched on.

³ This menu is only visible when the accessory is connected to the unit.

7.3.2 MAIN BOARD SETTINGS

> MENU > INSTALLER SETTINGS > MAIN BOARD SETTINGS

Menu item	Function
VENTILATION PRESETS	<p>To set the airflow of the position switch.</p> <ul style="list-style-type: none"> ■ PRESET A: set the airflow of the absent position (Default ComfoAir Q 350: 20 l/s) (Default ComfoAir Q 450: 20 l/s) (Default ComfoAir Q 600: 20 l/s) ■ PRESET 1: set the airflow of the low position (Default ComfoAir Q 350: 45 l/s) (Default ComfoAir Q 450: 60 l/s) (Default ComfoAir Q 600: 75 l/s) ■ PRESET 2: set the airflow of the normal position (Default ComfoAir Q 350: 65 l/s) (Default ComfoAir Q 450: 80 l/s) (Default ComfoAir Q 600: 100 l/s) ■ PRESET 3: set the airflow of the high position (Default ComfoAir Q 350: 80 l/s) (Default ComfoAir Q 450: 100 l/s) (Default ComfoAir Q 600: 125 l/s) <p>You cannot set a preset higher than the next preset. Thus it is best to set the maximum preset first and work back to the lower presets.</p>
VENTILATION CONTROL	<p>To set the mode of airflow control.</p> <ul style="list-style-type: none"> ■ FLOW CONTROL: the unit will regulate the airflow around the set airflow. External influences on the airflow will be corrected only when necessary, while small and short variations in airflow are allowed. This ensures a more steady behavior of the fan speed; (default setting) ■ CONSTANT FLOW: the unit will regulate the airflow to the exact set airflow. External influences on the airflow will be corrected immediately. The fan speed will constantly be corrected.
FILTER SETTINGS	<p>To set the RESET options of the filters.</p> <ul style="list-style-type: none"> ■ FILTER WARNING: to set the time necessary for ordering the new filters; (Default: 21 days) ■ RESET FILTER COUNT: to replace the filters before the filter warning has appeared. The internal counter of past air will be reset.
ALTITUDE	<p>To set the altitude range in which the system is installed.</p> <ul style="list-style-type: none"> ■ 0 - 500 m: the unit is maximally installed 500m above sea level; (default setting) ■ 500 - 1000 m: the unit is installed between 500 and 1000 meter above sea level; ■ 1000 - 1500 m: the unit is installed between 1000 and 1500 meter above sea level; ■ 1500 - 2000 m: the unit is installed between 1500 and 2000 meter above sea level.
FIRE PLACE PRESENT	<p>To set the presence of a fire place in the dwelling.</p> <ul style="list-style-type: none"> ■ NO: the unit will allow the function EXTRACT ONLY. A positive and a negative unbalance can be set in the UNBALANCE menu. (default setting) ■ YES: the unit will not allow the function EXTRACT ONLY. Only a positive unbalance can be set in the UNBALANCE menu.
UNBALANCE	<p>To set the required difference between the supply and extract air .</p> <ul style="list-style-type: none"> ■ 0 %: the unit will send the same amount of power to the supply air fan and extract air fan; (default setting) ■ positive %: the unit will decrease the airflow of the extract air; ■ negative %: the unit will decrease the airflow of the supply air.
DIRECT FAN CONTROL	not applicable (Do not activate)
SERVICE MODE	<p>To set the operating mode of the unit.</p> <ul style="list-style-type: none"> ■ ACTIVE MODE: the unit will function as intended; (default setting) ■ SERVICE MODE: the unit will turn off the basic functions of the unit and set the modulating by-pass valves to 50% to allow optimal access to all service parts.

7.3.3 OPTION BOX SETTINGS³

> MENU > INSTALLER SETTINGS > OPTION BOX SETTINGS³

Menu item	Function
SWITCH-ON DELAY	To set the time (delay timer) before the air volume will switch to PRESET 3 after closing the bathroom switch contact. (Default: 5 min) If the bathroom switch is stopped within the set time the unit will act like the bathroom switch has never been switched on.
SWITCH-OFF DELAY	To set the time (overrun timer) before the air volume will switch to the normal airflow after opening the bathroom switch contact. (Default: 5 min) <ul style="list-style-type: none"> ■ FIXED: set a fixed duration which must elapse before the air volume will switch to the normal airflow; ■ MIRROR: set the maximum duration which may elapse before the air volume will switch to the normal airflow. The unit will stay in PRESET 3 for the same duration as the time the bathroom switch had been switched on. If the bathroom switch has been switched on longer than the set time, the air volume will switch to the normal airflow when the timer runs out. (default setting)
POSTHEATER ³	To set the PI controller of the post-heater. <ul style="list-style-type: none"> ■ PROPORTIONAL BAND: set the proportional value of the post-heater; (Default: 2°C) ■ INTEGRAL TIME: set the integral value of the post-heater. (Default: 120s)
0-10V 1 ³	To set the control options of the first 0-10V input.
INPUT AT 0%	To set the required input signal to get 0% output signal from the unit; (Default: 0V) If positive control is necessary the input at 0% must be lower than the input at 100%: If negative control is necessary the input at 0% must be higher than the input at 100%.
INPUT AT 100%	To set the required input signal to get 100% output signal from the unit; (Default: 10V) If positive control is necessary the input at 100% must be higher than the input at 0%: If negative control is necessary the input at 100% must be lower than the input at 0%.
METHOD	To set the control method for the 0-10V input. <ul style="list-style-type: none"> ■ STEER: the unit will follow the input signal at all times; (default setting) ■ 0..10V: the unit will control the output signal to a set point.
CONTROL SETTINGS	To set the values for the set point control (0..10V). <ul style="list-style-type: none"> ■ SET POINT: set the set point value of control method; (Default: 5V) ■ PROPORTIONAL BAND: set the proportional value of the control method; (Default:100%) ■ INTEGRAL TIME: set the integral value of the control method. (Default: 300s)
0-10V 2 ³	To set the control options of the second 0-10V input.
INPUT AT 0%	To set the required input signal to get 0% output signal from the unit; (Default: 0V) If positive control is necessary the input at 0% must be lower than the input at 100%: If negative control is necessary the input at 0% must be higher than the input at 100%.
INPUT AT 100%	To set the required input signal to get 100% output signal from the unit; (Default: 10V) If positive control is necessary the input at 100% must be higher than the input at 0%: If negative control is necessary the input at 100% must be lower than the input at 0%.
METHOD	To set the control method for the 0-10V input. <ul style="list-style-type: none"> ■ STEER: the unit will follow the input signal at all times; (default setting) ■ 0..10V: the unit will control the output signal to a set point.
CONTROL SETTINGS	To set the values for the set point control. <ul style="list-style-type: none"> ■ SET POINT: set the set point value of control method; (Default: 5V) ■ PROPORTIONAL BAND: set the proportional value of the control method; (Default:100%) ■ INTEGRAL TIME: set the integral value of the control method. (Default: 300s)
0-10V 3 ³	To set the control options of the third 0-10V input.
INPUT AT 0%	To set the required input signal to get 0% output signal from the unit; (Default: 0V) If positive control is necessary the input at 0% must be lower than the input at 100%: If negative control is necessary the input at 0% must be higher than the input at 100%.
INPUT AT 100%	To set the required input signal to get 100% output signal from the unit; (Default: 10V) If positive control is necessary the input at 100% must be higher than the input at 0%: If negative control is necessary the input at 100% must be lower than the input at 0%.
METHOD	To set the control method for the 0-10V input. <ul style="list-style-type: none"> ■ STEER: the unit will follow the input signal at all times; (default setting) ■ 0..10V: the unit will control the output signal to a set point.
CONTROL SETTINGS	To set the values for the set point control. <ul style="list-style-type: none"> ■ SET POINT: set the set point value of control method; (Default: 5V) ■ PROPORTIONAL BAND: set the proportional value of the control method; (Default:100%) ■ INTEGRAL TIME: set the integral value of the control method. (Default: 300s)

³ This menu is only visible when the accessory is connected to the unit.

Menu item	Function
0-10V 4 ³	To set the control options of the fourth 0-10V input.
INPUT AT 0%	To set the required input signal to get 0% output signal from the unit; (Default: 0V) If positive control is necessary the input at 0% must be lower than the input at 100%: If negative control is necessary the input at 0% must be higher than the input at 100%.
INPUT AT 100%	To set the required input signal to get 100% output signal from the unit; (Default: 10V) If positive control is necessary the input at 100% must be higher than the input at 0%: If negative control is necessary the input at 100% must be lower than the input at 0%.
METHOD	To set the control method for the 0-10V input. <ul style="list-style-type: none"> ■ STEER: the unit will follow the input signal at all times; (default setting) ■ 0..10V: the unit will control the output signal to a set point.
CONTROL SETTINGS	To set the values for the set point control. <ul style="list-style-type: none"> ■ SET POINT: set the set point value of control method; (Default: 5V) ■ PROPORTIONAL BAND: set the proportional value of the control method; (Default:100%) ■ INTEGRAL TIME: set the integral value of the control method. (Default: 300s)
0-10V FUNCTION ³	To set the function of the ancillary connected to the 0-10V inputs. <ul style="list-style-type: none"> ■ FLOW-PROPORTIONAL: the unit will translate the incoming signal from an 0-10V sensor into a corresponding airflow request between the minimal and maximal set airflow; (default setting) ■ FLOW-PRESET: the unit will translate the incoming signal from an 0-10V sensor into one of the airflow presets.
0-10V PRIORITY ³	To set the airflow request priority of the ancillary connected to the 0-10V inputs. <ul style="list-style-type: none"> ■ ON: the unit will translate the signal from an 0-10V sensor to an airflow request in the AUTO mode and MANUAL mode; ■ AUTO ONLY: the unit will only translate the signal from an 0-10V sensor to an airflow request in the AUTO mode; ■ OFF: the unit will ignore the signal from an 0-10V sensor. (default setting)



7.3.4 LOG OUT

> MENU > INSTALLER SETTINGS > LOGOUT

Menu item	Function
LOGOUT	To block access to the INSTALLER SETTINGS menu.

7.3.5 RESET

> MENU > INSTALLER SETTINGS > RESET

Menu item	Function
FACTORY DEFAULTS	To return all software values to the default values.  You must commission the unit again.
RESET ERRORS	To reset all active error messages. When the error causing the message is not solved the error message will come back again over time.
RESET ANALYSIS	To reset all the values in > MENU > STATUS
PERIPHERALS ERRORS	To disconnect all ancillaries causing an error messages from the software.  Do not use this menu when the functions of the ancillaries causing the error message are necessary.

³ This menu is only visible when the accessory is connected to the unit.

8 Maintenance procedures

! Follow all maintenance procedures given in this chapter and in the user manual. If the maintenance is not performed periodically the performance of the ventilation system will ultimately be compromised.

In this chapter you can find a separate subchapter for each maintenance action which the user should not perform. In the user manual you can find the maintenance action which the user may perform.

👉 You can reset the counter for the filter change warning in the reset filter count menu. (INSTALLER SETTINGS > MAIN BOARD SETTINGS > FILTER SETTINGS > RESET FILTER COUNT)

You can find the maintenance procedures of the ancillaries connected to the unit in their relevant manuals. You can get a copy of a Zehnder manual from Zehnder.







If it is necessary to replace a part you can order a service part from Zehnder. In the chapter about the service parts you can see which special service sets are available.

⚠️ Always disconnect the power supply of the unit before you start working on the ventilation system. The unit can cause personal injury when it is open while running. Make sure the unit cannot switch back on by accident.

! Always take ESD-inhibiting measures when dealing with electronics, such as wearing an antistatic wristband. The electronics can get damaged by static charges.

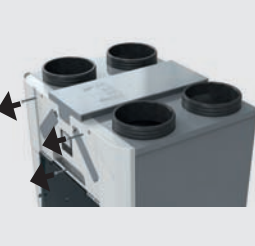

Zehnder recommend that you employ a specialised cleaning firm to clean the whole ventilation system.

8.1 Procedure for opening the unit

	<p>1</p> 	<p>2</p> 
<p>👉 Do not disconnect the power to the unit yet. The current setting of the modulating by-pass valve may block the removal of the heat exchanger.</p>	<p>Open the semi-transparent visor.</p>	<p>Change the unit to SERVICE MODE. (INSTALLER SETTINGS > MAIN BOARD SETTINGS > SERVICE MODE > SERVICE MODE).</p>
<p>3</p> 	<p>4</p> 	<p>5</p> 
<p>Disconnect the power to the unit when the display tells you to.</p>	<p>Remove the 3 screws of the front cover.</p>	<p>Remove the front cover.</p>



8.2 Maintenance of the casing

Inspect the unit casing at least once every 4 years.

<p>1</p> 	<p>2</p> 	<p>3</p> 
<p>Remove the front cover as instructed in the chapter procedure for opening the unit:</p> <ul style="list-style-type: none"> ■ Open the semi-transparent visor; ■ Change the unit to SERVICE MODE; ■ Disconnect the power to the unit; ■ Remove the 3 screws of the front cover; ■ Remove the front cover. 	<p>Perform the next checks:</p> <ul style="list-style-type: none"> ■ Check the seals for damage; ■ Check the inside and outside for dirt and damage; ■ Check the duct connections for dirt and damage. 	<p>Treat any signs of corrosion and other damage directly and appropriately.</p>



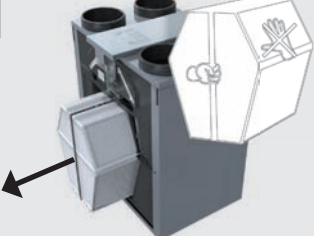

8.3 Maintenance of the heat exchanger

Inspect the heat exchanger at least once every 4 years.



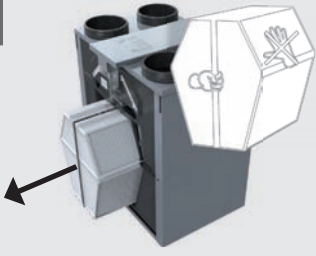

<p>1</p> 	<p>2</p> 	<p>3</p> 
<p>Remove the front cover as instructed in the chapter procedure for opening the unit:</p> <ul style="list-style-type: none"> ■ Open the semi-transparent visor; ■ Change the unit to SERVICE MODE; ■ Disconnect the power to the unit; ■ Remove the 3 screws of the front cover; ■ Remove the front cover. 	<p>Remove the heat exchanger:</p> <ul style="list-style-type: none"> ■ Pull the strap of the heat exchanger. <p>! Do not cut the strap. The strap is necessary to pull out the heat exchanger from the unit.</p> <p>You can only remove the heat exchanger when the unit is in SERVICE MODE.</p>	<p>Inspect and, if necessary, clean the heat exchanger.</p> <ul style="list-style-type: none"> ■ Use water to remove dirt and dust: <ol style="list-style-type: none"> a. Submerge the heat exchanger several times in hot water (max. 40°C). b. Rinse the heat exchanger with clean hot tap water (max. 40°C). c. Clasp the heat exchanger between both hands (on the solid side surfaces) and shake the excess water from the heat exchanger. <p>! Do not use aggressive cleaning agents or solvents. These may damage the air seal of the heat exchanger.</p>

8.4 Maintenance of the fans

Inspect the fans at least once every 4 years.

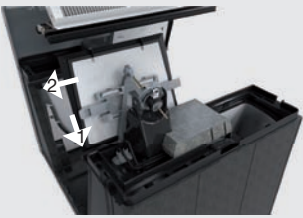
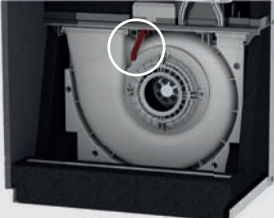
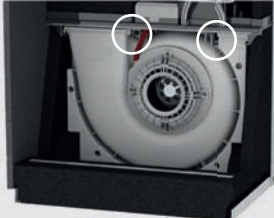
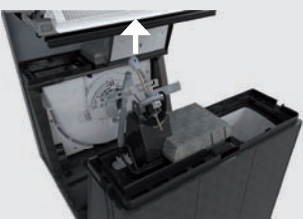
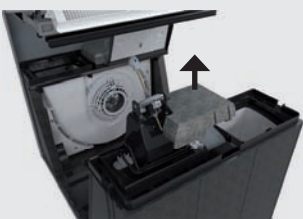

		
<p>Remove the heat exchanger as instructed in the maintenance instruction of the heat exchanger:</p> <ul style="list-style-type: none"> ■ Open the semi-transparent visor; ■ Change the unit to SERVICE MODE; ■ Disconnect the power to the unit; ■ Remove the 3 screws of the front cover; ■ Remove the front cover; ■ Pull the strap of the heat exchanger. 	<p>Perform the next checks:</p> <ul style="list-style-type: none"> ■ Check the flow grid for dirt and damage; ■ Check the casing for dirt and damage; ■ Check the fan impellers for dirt and damage. 	<p>If necessary, clean the fans and flow grid.</p> <ul style="list-style-type: none"> ■ Use a soft brush to clean the fan impellers; ■ Use a vacuum cleaner to remove dust. <p> Take care to ensure the fan impellers do not get damaged.</p>

For better access to the fan follow the next steps:

		
<p>Remove the modulating by-pass valve as instructed in its relevant chapter:</p> <ul style="list-style-type: none"> ■ Open the semi-transparent visor; ■ Change the unit to SERVICE MODE; ■ Disconnect the power to the unit; ■ Remove the 3 screws of the front cover; ■ Remove the front cover; ■ Pull the strap of the heat exchanger. ■ Pull the clamp, located at the back of the valve, away from the valve. ■ While holding the clamp away from the valve pull the valve towards you. 	<p>Remove the two pressure hoses from the fan.</p>	<p>Press the two holding clamps downwards and pull the scroll housing forwards.</p>
		
<p>Release the connection joint of the modulating by-pass valve.</p>	<p>Remove the insulation cover behind the modulating by-pass valve.</p>	<p>Remove the fan connectors from the sensor cover and open them.</p>
		
<p>Remove the grommet including cabling.</p>	<p>Lift the scroll housing out of the unit.</p>	<p>Remove the 5 screws on the edge of the scroll housing to open the scroll housing.</p>



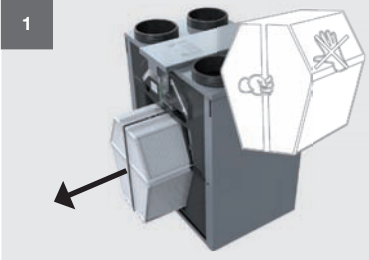
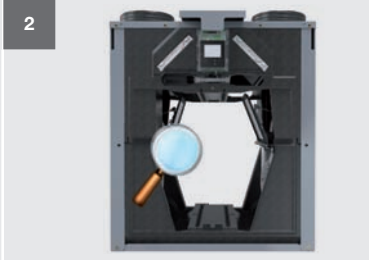



8.5 Maintenance of the modulating by-pass valves

Inspect the modulating by-pass valves at least once every 4 years.

		
<p>Remove the heat exchanger as instructed in the maintenance instruction of the heat exchanger:</p> <ul style="list-style-type: none"> ■ Open the semi-transparent visor; ■ Change the unit to SERVICE MODE; ■ Disconnect the power to the unit; ■ Remove the 3 screws of the front cover; ■ Remove the front cover; ■ Pull the strap of the heat exchanger. 	<p>Inspect the modulating by-pass valves for dirt and damage.</p>	<p>Treat any signs of dirt or damage directly and appropriately.</p> <p> Remove the modulating by-pass valve for easy cleaning. You can find the instructions for removing the modulating by-pass valve in the chapter "How to remove the modulating by-pass valve".</p>

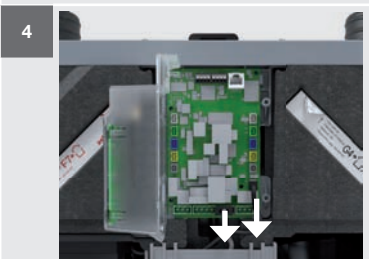

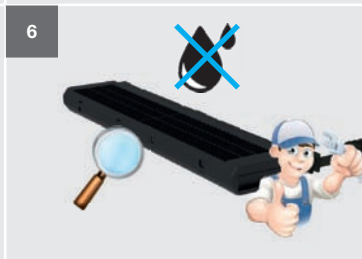
8.6 Maintenance of the pre-heater

Inspect the pre-heater at least once every 4 years.

		
<p>Remove the front cover as instructed in the chapter procedure for opening the unit:</p> <ul style="list-style-type: none"> ■ Open the semi-transparent visor; ■ Change the unit to SERVICE MODE; ■ Disconnect the power to the unit; ■ Remove the 3 screws of the front cover; ■ Remove the front cover. 	<p>Pull the cable tray cover forwards.</p>	<p>Unscrew the 2 screws of the display cover. Open the display cover.</p>
		
<p>Remove the pre-heater communication and power cable from the main board.</p>	<p>Remove the pre-heater, including its cable and grommet, from the unit.</p>	<p>Inspect the pre-heater for dirt and damage.</p> <p>Treat any signs of dirt or damage directly and appropriately.</p> <p>Turn the pre-heater upside down and:</p> <ul style="list-style-type: none"> ■ Use a soft brush to clean the fins; ■ Or use a vacuum cleaner to remove dirt and dust. <p> Do not wet-clean the pre-heater.</p>



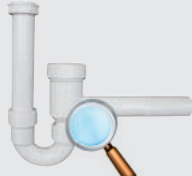

8.7 Maintenance of the condensation drain

Inspect the condensation drain at least once every 4 years.



<p>1 Example siphon</p> 	<p>2 Example siphon</p> 	<p>3</p> 
<p>Disconnect the condensation drain.</p>	<p>Perform the next checks on the condensation drain siphon:</p> <ul style="list-style-type: none"> ■ Check whether the drain is still open by adding water to the siphon; ■ Visually inspect the condensation drain for contamination; ■ Check if the seal of the condensation drain is air tight. Air must not pass through or by the siphon. 	<p>Resolve any seen problems.</p>

8.8 Maintenance of the air ducts





Inspect the air ducts at least once every 4 years.

<p>1 Example valve Example grille</p> 	<p>2 Example air duct</p> 	<p>3</p> 
<p>Remove the valves and/or grilles.</p> <p> Zehnder recommends noting down the setting and location before removal.</p>	<p>Perform the next checks on the air ducts:</p> <ul style="list-style-type: none"> ■ Pollution (dirt and grease); ■ Air leakage (loose joints); ■ Resistance (bends, dents and blocked valves); ■ Valves and/or grilles. 	<p>Resolve any seen problems.</p>

With nominal use the exhaust must be cleaned every 4 years and the supply every 8 years.

<p>1 Example brush</p> 	<p>2 Example vacuum cleaner</p> 	
<p>Loosen the dirt.</p>	<p>Remove the dirt with a vacuum cleaner or filter box.</p> <p> Do not use the unit to remove the dirt from the air ducts. The dirt can damage the unit or furniture in the dwelling.</p>	

8.9 Procedure for ending the maintenance

<p>1</p>  <p>Install all parts back in reverse order.</p>	<p>! During installation:</p> <ul style="list-style-type: none">■ Set the unit in SERVICE MODE when the modulating by-pass valves are blocking the installation of the heat exchanger;■ Tighten all screws manually (max. 1.5 Nm);■ Place all cables in their guiding channels;■ Place the bottom edge of the front behind the raised edge of the bottom plate. <p>This will guarantee an air-tight seal after the screws are tightened.</p>		
<p>2</p>  <p>Connect the power to the unit.</p>	<p>3</p>  <p>Stop the SERVICE MODE. (MENU > INSTALLER SETTINGS > MAIN BOARD SETTINGS > SERVICE MODE > ACTIVE MODE).</p>	<p>4</p> <p>Example report</p>  <p>Fill in the maintenance log. You can find the maintenance log in the user manual.</p>	

9. Malfunction procedures

⚠ Always disconnect the power supply of the unit before you start working on the unit. The unit can cause personal injury when it is open while running. Make sure the unit cannot switch back on by accident.

⚠ Always take ESD-inhibiting measures when dealing with electronics, such as wearing an antistatic wristband. The electronics can get damaged by static charges.

In the chapter what to do in the event of a malfunction alert (troubleshooting) you can find how to solve all malfunction codes.

9.1 How to gain access to the ComfoNet connectors on the unit





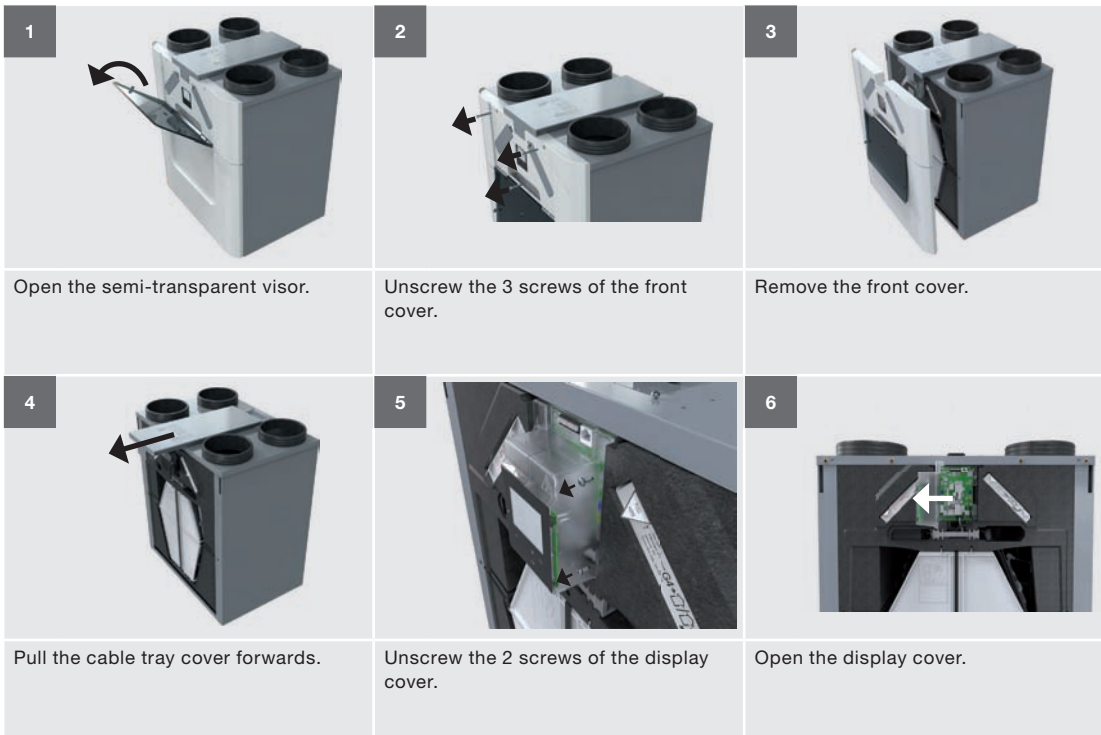



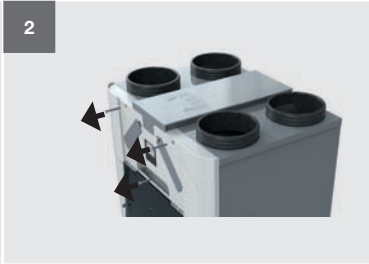
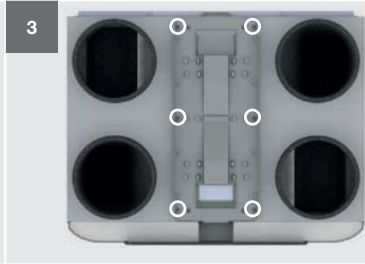

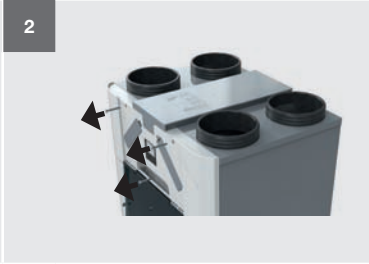

9.2 How to gain access to the control PCB

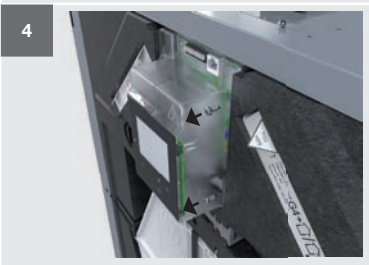
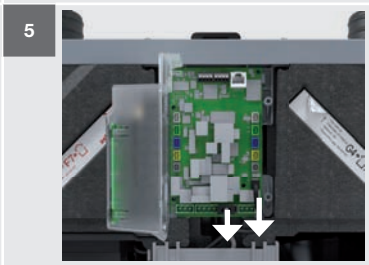
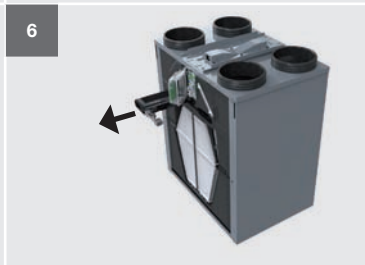

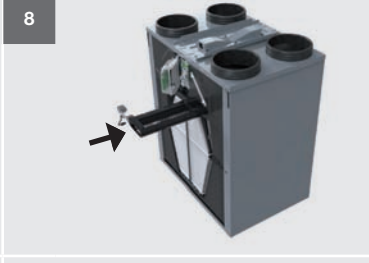





9.3 How to gain access to the main power fuse of the unit

		
<p>Open the semi-transparent visor.</p>	<p>Pull the cable tray cover forwards.</p>	<p>Remove the 6 screws of the cable tray. Carefully lift up the cable tray.</p>

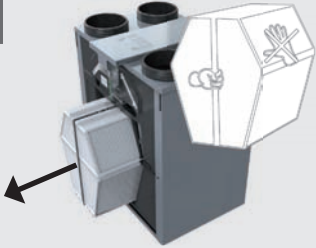
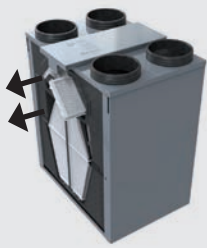
9.4 How to change the location of the pre-heater

		
<p>Open the semi-transparent visor.</p>	<p>Unscrew the 3 screws of the front cover. Remove the front cover.</p>	<p>Pull the cable tray cover forwards.</p>
		
<p>Unscrew the 2 screws of the display cover. Open the display cover.</p>	<p>Pull the pre-heater communication and power cable from the control PCB.</p>	<p>Pull the pre-heater, including its cable and grommet, from the unit.</p>
		
<p>Rotate the pre-heater 180°.</p>	<p>Slide the pre-heater, including its cable and grommet, back on the other side of the unit.</p>	<p>Check if the filters are in the correct position:</p> <ul style="list-style-type: none"> ■ When the supply and extract air are to the right side of the unit the filter locations are: <ul style="list-style-type: none">  = Left side;  = Right side. ■ When the supply and extract air are to the left side of the unit the filter locations are: <ul style="list-style-type: none">  = Left side;  = Right side.

9.5 How to gain access to the top-section sensor

<p>1</p> 	<p>2</p> 	<p>3</p> 
<p>Remove the heat exchanger as instructed in the maintenance instruction of the heat exchanger:</p> <ul style="list-style-type: none"> ■ Open the semi-transparent visor; ■ Change the unit to SERVICE MODE; ■ Disconnect the power to the unit; ■ Remove the 3 screws of the front cover; ■ Remove the front cover; ■ Pull the strap of the heat exchanger. 	<p>Remove the filters (and when present the pre-heater).</p> <p>During installation:</p> <ul style="list-style-type: none"> ■ Make sure the arrow on the filters is pointing upwards. ■ When the supply and extract air are to the right side of the unit the filter locations are: <ul style="list-style-type: none">  = Left side;  = Right side. ■ When the supply and extract air are to the left side of the unit the filter locations are: <ul style="list-style-type: none">  = Left side;  = Right side. 	<p>Pull the sensor, from the inside of the unit, down. Then remove the sensor connector.</p> 

9.6 How to remove the modulating by-pass valve

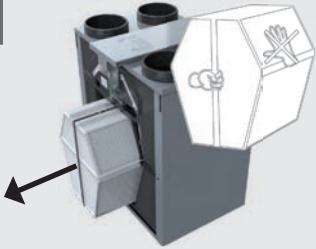
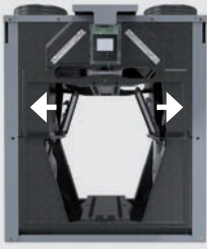
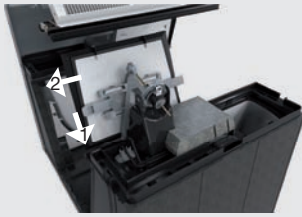
<p>1</p> 	<p>2</p> 	<p>3</p> 
<p>Remove the heat exchanger as instructed in the maintenance instruction of the heat exchanger:</p> <ul style="list-style-type: none"> ■ Open the semi-transparent visor; ■ Change the unit to SERVICE MODE; ■ Disconnect the power to the unit; ■ Remove the 3 screws of the front cover; ■ Remove the front cover; ■ Pull the strap of the heat exchanger. 	<p>Pull the clamp, located at the back of the valve, away from the valve.</p>	<p>While holding the clamp away from the valve pull the valve towards you.</p>

9.7 How to gain access to the mid-section sensor

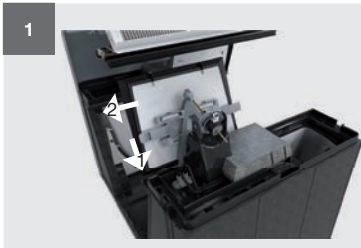

Remove the modulating by-pass valve as instructed in its relevant chapter:

- Open the semi-transparent visor;
- Change the unit to SERVICE MODE;
- Disconnect the power to the unit;
- Remove the 3 screws of the front cover;
- Remove the front cover;
- Pull the strap of the heat exchanger.
- Pull the clamp, located at the back of the valve, away from the valve.
- While holding the clamp away from the valve pull the valve towards you.

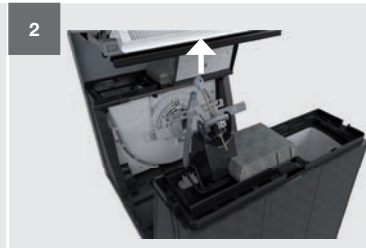

Release the connection joint of the modulating by-pass valve.

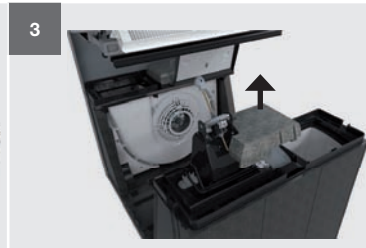

Remove the insulation cover behind the modulating by-pass valve.



Remove the fan connectors from the sensor cover.
Remove the sensor cover by opening the snap connection.



During installation: Place the sensor cover underneath the guide rails and place the fan connectors back. This will guarantee a good fit of the insulation cover.

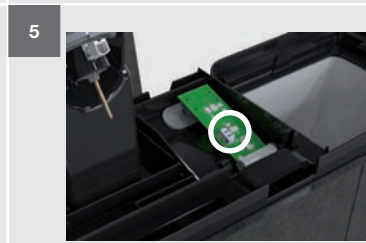

Remove the connector for the sensor

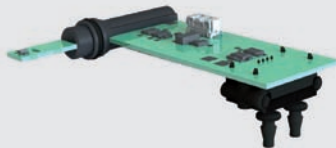

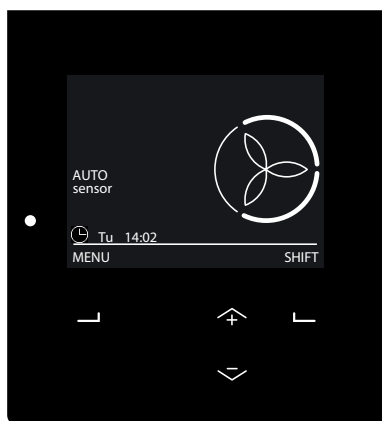

Pull the sensor up out of its rubber pressure sensor holder.
Then pull the sensor sideways and out of the sensor compartment.

9.8 Malfunction alerts on the display of the unit



When there is a malfunction in the unit the LED next to the display of the unit will flash.

When accessing the display the corresponding malfunction code will be displayed.

Code	Meaning
AIRFLOW_EHA ERROR	The exhaust airflow is not reaching its set point.
AIRFLOW_SUP ERROR	The supply airflow is not reaching its set point.
DANGER! OVERHEATING!	Two or more sensors are detecting an incorrect temperature.  The ventilation has stopped. Fix the error as soon as possible to prevent build-up of moisture and CO₂.
EXTERNAL FILTER ALARM	It is necessary to replace or clean the external filter.
FAN_EHA ERROR	The exhaust air fan has a malfunction.
FAN_SUP ERROR	The supply air fan has a malfunction.
CHANGE FILTERS NOW	It is necessary to replace the internal filters.
EXPECT FILTER CHANGE SOON	It is almost necessary to replace the internal filters.  Order the new filters now.
FROST ERROR	The supply air temperature is too low.
GROUND_HEAT_CONNECT ERROR	There is no communication between the ComfoFond-L Q and the unit.
GROUND_HEAT_TEMP ERROR	The temperature sensor of the ComfoFond-L Q is detecting an incorrect temperature.
HUMID_EHA ERROR	The exhaust air humidity sensor is detecting an incorrect humidity.
HUMID_ETA ERROR	The extract air humidity sensor is detecting an incorrect humidity.
HUMID_ODA ERROR	The outdoor air humidity sensor is detecting an incorrect humidity.
HUMID_SUP ERROR	The supply air humidity sensor is detecting an incorrect humidity.
INIT ERROR	The unit has not been commissioned.
OPTION_BOX CONNECT ERROR	There is no communication between the option box and the unit.
POSTHEAT_CONNECT ERROR	There is no communication between the post-heater and the unit.
POSTHEAT_TEMP ERROR	The temperature sensor of the post-heater is detecting an incorrect temperature.
PREHEAT ERROR	The pre-heater has a malfunction.
PREHEAT_PRES ERROR	There is no communication between the pre-heater and the unit.
PREHEAT_LOCATION ERROR	The pre-heater is not in the expected location.
PRESSURE_EHA ERROR	The exhaust air pressure sensor has a malfunction.
PRESSURE_SUP ERROR	The supply air pressure sensor has a malfunction.
SENSOR_EHA ERROR	The exhaust air sensor has a malfunction.
SENSOR_ETA ERROR	The extract air sensor has a malfunction.
SENSOR_ODA ERROR	The outdoor air sensor has a malfunction.
SENSOR_SUP ERROR	The supply air sensor has a malfunction.
SERVICE MODE	The basic functions of the unit are stopped.  The ventilation has stopped. Fix the error as soon as possible to prevent build-up of moisture.
TEMPCONTROL_SUP ERROR	The modulating by-pass actuators have a malfunction.
TEMP_SENSOR_EHA ERROR	The exhaust air temperature sensor is detecting an incorrect temperature.
TEMP_SENSOR_ETA ERROR	The extract air temperature sensor is detecting an incorrect temperature.
TEMP_SENSOR_ODA ERROR	The outdoor air temperature sensor is detecting an incorrect temperature.
TEMP_SENSOR_SUP ERROR	The supply air temperature sensor is detecting an incorrect temperature.

9.9 Malfunction alerts on the ComfoSense C



When a malfunction code appears on the ComfoSense C the corresponding malfunction code will also appear on the display of the unit.

9.10 Malfunction alerts on the ComfoSwitch C



You can find a FILTER LED on the ComfoSwitch C. When it is necessary to replace the filters this LED emits a red light.

When there is a malfunction alert on the display of the unit all the LED's of the ComfoSwitch C will flash.

9.12 Malfunction alerts on the Control App



The same malfunction code which can appear on the display of the unit will also appear in the control app.



9.12 Malfunction alerts on the Timer RF



The Timer RF only displays a malfunction alert when there is no communication between the unit and the controller.



Other malfunctions are not displayed by this controller.

9.14 What to do in the event of a malfunction alert (troubleshooting)

Malfunction code AIRFLOW_EHA ERROR / AIRFLOW_SUP ERROR.		The exhaust / supply airflow is not reaching its set point.	
Question	Answer	Action	
1	Is one or more of the valves and/or grilles blocked?	Yes	<ol style="list-style-type: none"> 1. Set the valves and/or grilles to the correct settings. 2. Reset the errors as instructed in the chapter "How to reset errors". 3. Wait 2 minutes. 4. Go to the next question.
		No	<ol style="list-style-type: none"> 1. Inspect the air ducts as instructed in the chapter "Maintenance of the air ducts". 2. Reset the errors as instructed in the chapter "How to reset errors". 3. Wait for 2 minutes. 4. Go to the next question.
2	Did the error come back?	Yes	<ol style="list-style-type: none"> 1. Check all the filters. 2. Go to the next question.
		No	Follow the procedure for ending the maintenance.
3	Are the filters dirty? (internal and external)	Yes	<ol style="list-style-type: none"> 1. Replace the filters as instructed in the user manual or its supplied manual. 2. Follow the instructions mentioned at the answer "No".
		No	<ol style="list-style-type: none"> 1. Inspect the heat exchanger, the pre-heater, and the fans, as instructed in their relevant maintenance chapter. Keep the unit open and the heat exchanger removed after finishing all the maintenance. 2. Connect the power to the unit. <p> Risk of electrical shock.</p> <ol style="list-style-type: none"> 3. Stop the service mode as instructed in the chapter "How to change the operation mode of the unit". 4. Reset the errors as instructed in the chapter "How to reset errors". 5. Wait for 2 minutes. 6. Go to the next question.
4	Did the error come back?	Yes	<ol style="list-style-type: none"> 1. Disconnect the power from the unit. 2. Check the two hoses on the top side of the fan. 3. Go to the next question.
		No	<ol style="list-style-type: none"> 1. Disconnect the power from the unit. 2. Follow the procedure for ending the maintenance.
5	Are the two fan hoses connected correctly?	Yes	Go to the next question.
		No	<ol style="list-style-type: none"> 1. Reconnect the hoses. 2. Connect the power to the unit. <p> Risk of electrical shock.</p> <ol style="list-style-type: none"> 3. Reset the errors as instructed in the chapter "How to reset errors". 4. Wait for 2 minutes. 5. Go to the next question.
6	Did the error come back?	Yes	<ol style="list-style-type: none"> 1. Disconnect the power from the unit. 2. Follow the procedure for ending the maintenance. 3. Run the complete commissioning wizard. 4. Reset the errors as instructed in the chapter "How to reset errors".
		No	<ol style="list-style-type: none"> 1. Disconnect the power from the unit. 2. Follow the procedure for ending the maintenance.

Malfunction code DANGER! OVERHEATING!.		Two or more sensors are detecting an incorrect temperature.	
Question	Answer	Action	
Was the temperature < -40°C or > 70°C?	Yes	<ol style="list-style-type: none"> 1. Reset the errors as instructed in the chapter "How to reset errors". 2. Perform all maintenance actions to check if there is permanent damage to the system. 	
	No	Solve the sensor errors as instructed in their relevant trouble shooting table.	

Malfunction code EXTERNAL FILTER ALARM.		It is necessary to replace or clean the external filter.	
Question	Answer	Action	
not applicable	not applicable	<ol style="list-style-type: none"> 1. Replace or clean the external filter as instructed in its relevant manual. 2. Reset the errors as instructed in the chapter "How to reset errors". 	

Malfunction code FAN_EHA ERROR / FAN_SUP ERROR.		The exhaust / supply air fan has a malfunction.	
	Question	Answer	Action
1	not applicable	not applicable	<ol style="list-style-type: none"> 1. Disconnect the power from the unit. 2. Access the control PCB as instructed in the chapter "How to gain access to the control PCB". 3. Go to the next question.
2	Are the connections at the control PCB correct? ⁴	Yes	<ol style="list-style-type: none"> 1. Inspect the fan as instructed in the chapter "Maintenance of the fans". Keep the unit open and the heat exchanger removed after finishing all the maintenance. 2. Connect the power to the unit. <p> Risk of electrical shock.</p> <ol style="list-style-type: none"> 3. Stop the service mode as instructed in the chapter "How to change the operation mode of the unit". 4. Reset the errors as instructed in the chapter "How to reset errors". 5. Wait for 2 minutes. 6. Go to the next question.
		No	<ol style="list-style-type: none"> 1. Reconnect the fan. 2. Connect the power to the unit. <p> Risk of electrical shock.</p> <ol style="list-style-type: none"> 3. Reset the errors as instructed in the chapter "How to reset errors". 4. Wait for 2 minutes. 5. Go to the last question.
3	Did the error come back?	Yes	<ol style="list-style-type: none"> 1. Disconnect the power from the unit. 2. Get the fan service set. 3. Replace the fan as instructed in its supplied manual. Keep the unit open and the heat exchanger removed after replacing the fan. 4. Connect the power to the unit. <p> Risk of electrical shock.</p> <ol style="list-style-type: none"> 5. Reset the errors as instructed in the chapter "How to reset errors". 6. Wait for 2 minutes. 7. Go to the next question.
		No	<ol style="list-style-type: none"> 1. Disconnect the power from the unit. 2. Follow the procedure for ending the maintenance.
4	Did the error come back?	Yes	<ol style="list-style-type: none"> 1. Disconnect the power from the unit. 2. Get the control PCB service set. 3. Replace the control PCB as instructed in its supplied manual. 4. Follow the procedure for ending the maintenance. 5. Reset the errors as instructed in the chapter "How to reset errors".
		No	<ol style="list-style-type: none"> 1. Disconnect the power from the unit. 2. Follow the procedure for ending the maintenance.

Malfunction code CHANGE FILTERS NOW		It is necessary to replace the internal filters.	
	Question	Answer	Action
	not applicable	not applicable	Replace the filters right away as instructed in the user manual.

Malfunction code EXPECT FILTER CHANGE SOON		It is almost necessary to replace the internal filters.	
	Question	Answer	Action
	not applicable	not applicable	<ol style="list-style-type: none"> 1. Order new filters. 2. Replace the filters as instructed in the user manual.

Malfunction code FROST ERROR.		The supply air temperature is too low.	
Action			
Wait till the outdoor temperature increases to at least -7°C.			

⁴ You can find the correct connection in the technical specification chapter.

Malfunction code HUMID_ETA ERROR / HUMID_ODA ERROR		The extract / outdoor air humidity sensor is detecting an incorrect humidity.	
	Question	Answer	Action
1	Is the humidity protection on? ⁵	Yes	1. Increase the ventilation to maximum. 2. Reset the errors as instructed in the chapter "How to reset errors". 3. Wait for 2 minutes. 4. Go to the last question.
		No	1. Switch on the humidity protection. 2. Reset the errors as instructed in the chapter "How to reset errors". 3. Wait for 2 minutes. 4. Go to the next question.
2	Did the error come back?	Yes	1. Increase the ventilation to maximum. 2. Reset the errors as instructed in the chapter "How to reset errors". 3. Wait for 2 minutes. 4. Go to the next question.
		No	Fill in the maintenance log.
3	Did the error come back?	Yes	Follow the instructions of the SENSOR_ETA ERROR / SENSOR_ODA ERROR table.
		No	Fill in the maintenance log.

Malfunction code HUMID_EHA ERROR / HUMID_SUP ERROR		The exhaust / supply air humidity sensor is detecting an incorrect humidity.	
	Question	Answer	Action
1	Is the humidity protection on? ⁵	Yes	1. Increase the ventilation to maximum. 2. Reset the errors as instructed in the chapter "How to reset errors". 3. Wait 2 minutes. 4. Go to the last question.
		No	1. Switch on the humidity protection. 2. Reset the errors as instructed in the chapter "How to reset errors". 3. Wait for 2 minutes. 4. Go to the next question.
2	Did the error come back?	Yes	1. Increase the ventilation to maximum. 2. Reset the errors as instructed in the chapter "How to reset errors". 3. Wait for 2 minutes. 4. Go to the next question.
		No	Fill in the maintenance log.
3	Did the error come back?	Yes	Follow the instructions of the SENSOR_EHA ERROR / SENSOR_SUP ERROR table.
		No	Fill in the maintenance log.

Malfunction code INIT ERROR		The unit has not been commissioned.	
Action			
1. Commission the unit by running the commission wizard. 2. Fill in the maintenance log.			

⁵ You can find the humidity protection settings in menu
> MENU > ADVANCED SETTINGS > SENSOR VENTILATION > HUMIDITY PROTECTION



Malfunction code OPTION_BOX CONNECT ERROR.			No communication between the option box and the unit.
	Question	Answer	Action
1	not applicable	not applicable	1. Access the ComfoNet connectors as instructed in the chapter "How to gain access to the ComfoNet connectors on the unit". 2. Go to the next question.
2	Are the connections at the ComfoNet connector correct? ⁴	Yes	1. Access the option box connections. 2. Go to the next question.
		No	1. Reconnect the option box to the unit. 2. Follow the procedure for ending the maintenance.
3	Are the connections at the option box correct? ⁴	Yes	Go to the next question.
		No	1. Reconnect the option box to the unit. 2. Fill in the maintenance log.
4	Is something wrong with the option box cable?	Yes	1. Replace the cable. 2. Follow the procedure for ending the maintenance.
		No	1. Get a new option box. 2. Replace the option box. 3. Wait for 2 minutes. 4. Go to the next question.
5	Is the error still present?	Yes	1. Get the control PCB service set. 2. Replace the control PCB as instructed in its supplied manual. 3. Follow the procedure for ending the maintenance.
		No	Follow the procedure for ending the maintenance.

Malfunction code GROUND_HEAT_CONNECT ERROR / POSTHEAT_CONNECT ERROR.			There is no communication between the ComfoFond-L Q / post-heater and the unit.
	Question	Answer	Action
1	not applicable	not applicable	1. Access the option box connectors. 2. Go to the next question.
2	Are the connections at the option box correct? ⁴	Yes	1. Access the connections on the ancillary side. 2. Go to the next question.
		No	1. Reconnect the ancillary to the option box. 2. Fill in the maintenance log.
3	Are the connections at the ancillary side correct? ⁷	Yes	Go to the next question.
		No	1. Reconnect the ancillary to the option box. 2. Follow the procedure for ending the maintenance.
4	Is something wrong with the cable?	Yes	1. Replace the cable. 2. Follow the procedure for ending the maintenance.
		No	1. Get a new ancillary. 2. Replace the ancillary. 3. Go to the next question.
5	Is the error still present?	Yes	1. Get the control PCB service set. 2. Replace the control PCB as instructed in its supplied manual. 3. Follow the procedure for ending the maintenance.
		No	Follow the procedure for ending the maintenance.

⁴ You can find the correct connection in the technical specification chapter.

⁷ You can find the correct connection in the manual of the ancillary.

Malfunction code GOUND_HEAT_TEMP ERROR / POSTHEAT_TEMP ERROR		The temperature sensor of the ComfoFond-L Q / post-heater is detecting an incorrect temperature.	
	Question	Answer	Action
1	Is the temperature in the ComfoFond-L Q / ComfoHood / post-heater between -40°C and +70°C.	Yes	1. Solve the problem for the extreme temperature. 2. Go to the next question.
		No	1. Access the option box connectors. 2. Go to the last question.
2	Did the error come back?	Yes	1. Access the option box connectors. 2. Go to the next question.
		No	Fill in the maintenance log.
3	Are the connections at the option box correct? ⁴	Yes	1. Get the correct sensor service set or new ancillary. 2. Replace the sensor as instructed in its supplied manual or replace the ancillary. 3. Fill in the maintenance log.
		No	1. Reconnect the sensor to the option box. 2. Fill in the maintenance log.

Malfunction code PREHEAT ERROR.		The pre-heater has a malfunction.	
	Question	Answer	Action
1	not applicable	not applicable	1. Inspect the pre-heater as instructed in the chapter "Maintenance of the pre-heater". Keep the unit open after finishing all the maintenance. 2. Connect the power to the unit.  Risk of electrical shock. 3. Stop the service mode as instructed in the chapter "How to change the operation mode of the unit". 4. Reset the errors as instructed in the chapter "How to reset errors". 5. Wait for 2 minutes. 6. Go to the next question.
2	Did the error come back?	Yes	1. Disconnect the power from the unit. 2. Get the pre-heater service set. 3. Replace the pre-heater as instructed in its supplied manual. 4. Disconnect the power from the unit.  Risk of electrical shock. 5. Reset the errors as instructed in the chapter "How to reset errors". 6. Wait for 2 minutes. 7. Go to the next question.
		No	1. Disconnect the power from the unit. 2. Follow the procedure for ending the maintenance.
3	Did the error come back?	Yes	1. Disconnect the power from the unit. 2. Get the control PCB service set. 3. Replace the control PCB as instructed in its supplied manual. 4. Follow the procedure for ending the maintenance. 5. Reset the errors as instructed in the chapter "How to reset errors".
		No	1. Disconnect the power from the unit. 2. Follow the procedure for ending the maintenance.

⁴ You can find the correct connection in the technical specification chapter.



⁸ You can find the orientation settings in menu
> MENU > STATUS > UNIT > HRU TYPE

Malfunction code PREHEAT_PRES ERROR.			There is no communication between the pre-heater and the unit.
	Question	Answer	Action
1	not applicable	not applicable	1. Disconnect the power from the unit. 2. Access the control PCB as instructed in the chapter "How to gain access to the control PCB". 3. Go to the next question.
2	Are the connections at the control PCB correct? ⁴	Yes	1. Get the pre-heater service set. 2. Replace the pre-heater as instructed in its supplied manual. 3. Connect the power to the unit.  Risk of electrical shock. 4. Reset the errors as instructed in the chapter "How to reset errors". 5. Wait for 2 minutes. 6. Go to the next question.
		No	1. Reconnect the pre-heater connectors. 2. Follow the procedure for ending the maintenance.
3	Did the error come back?	Yes	1. Disconnect the power from the unit. 2. Get the control PCB service set 3. Replace the control PCB as instructed in its supplied manual. 4. Follow the procedure for ending the maintenance. 5. Reset the errors as instructed in the chapter "How to reset errors".
		No	1. Disconnect the power from the unit. 2. Follow the procedure for ending the maintenance.



Malfunction code PREHEAT_LOCATION ERROR.			The pre-heater is not in the expected location.
	Question	Answer	Action
1	Is the orientation of the unit set correctly? ⁸	Yes	Change the location of the pre-heater as instructed in the chapter "How to change the location of the pre-heater".
		No	Set the orientation of the unit correct by running the complete commissioning wizard.

Malfunction code PRESSURE_EHA ERROR / PRESSURE_SUP ERROR.			The exhaust / supply air pressure sensor has a malfunction.
	Question	Answer	Action
1	not applicable	not applicable	1. Check the settings of all the valves and/or grilles. 2. Go to the next question.
2	Is one or more of the valves and/or grilles blocked?	Yes	1. Set the valves and/or grilles to the correct settings. 2. Reset the errors as instructed in the chapter "How to reset errors". 3. Go to the next question.
		No	Follow the instructions of the SENSOR_EHA ERROR / SENSOR_SUP ERROR table.
3	Did the error come back?	Yes	Follow the instructions of the SENSOR_EHA ERROR / SENSOR_SUP ERROR table.
		No	1. Inform the residents about the importance of the valve and/or grille settings. 2. Fill in the maintenance log.

⁴ You can find the correct connection in the technical specification chapter.

Malfunction code SENSOR_ETA ERROR / SENSOR_ODA ERROR.		The extract / outdoor air sensor has a malfunction.	
	Question	Answer	Action
1	not applicable	not applicable	<ol style="list-style-type: none"> 1. Disconnect the power from the unit. 2. Access the control PCB as instructed in the chapter "How to gain access to the control PCB". 3. Go to the next question.
2	Are the connections at the control PCB correct? ⁴	Yes	<ol style="list-style-type: none"> 1. Remove the heat exchanger as instructed in the chapter "Maintenance of the heat exchanger". 2. Remove the top-section sensor as instructed in the chapter "How to gain access to the top-section sensor". 3. Go to the next question.
		No	<ol style="list-style-type: none"> 1. Reconnect the sensor connector. 2. Follow the procedure for ending the maintenance.
3	Is the connection at the sensor correct?	Yes	<ol style="list-style-type: none"> 1. Connect the power to the unit. <p> Risk of electrical shock.</p> <ol style="list-style-type: none"> 2. Stop the service mode as instructed in the chapter "How to change the operation mode of the unit". 3. Reset the errors as instructed in the chapter "How to reset errors". 4. Wait for 2 minutes. 5. Go to the next question.
		No	<ol style="list-style-type: none"> 1. Reconnect the sensor connector. 2. Follow the procedure for ending the maintenance.
4	Did the error come back?	Yes	<ol style="list-style-type: none"> 1. Disconnect the power from the unit. 2. Get the top-section sensor service set. 3. Replace the sensor as instructed in its supplied manual. 4. Connect the power to the unit. <p> Risk of electrical shock.</p> <ol style="list-style-type: none"> 5. Reset the errors as instructed in the chapter "How to reset errors". 6. Wait for 2 minutes. 7. Go to the next question.
		No	<ol style="list-style-type: none"> 1. Disconnect the power from the unit. 2. Follow the procedure for ending the maintenance.
5	Did the error come back?	Yes	<ol style="list-style-type: none"> 1. Disconnect the power from the unit. 2. Get the control PCB service set. 3. Replace the control PCB as instructed in its supplied manual. 4. Follow the procedure for ending the maintenance. 5. Reset the errors as instructed in the chapter "How to reset errors".
		No	<ol style="list-style-type: none"> 1. Disconnect the power from the unit. 2. Follow the procedure for ending the maintenance.

⁴ You can find the correct connection in the technical specification chapter.

Malfunction code SENSOR_EHA ERROR / SENSOR_SUP ERROR.		The exhaust / supply air sensor has a malfunction.	
	Question	Answer	Action
1	not applicable	not applicable	<ol style="list-style-type: none"> 1. Disconnect the power from the unit. 2. Access the control PCB as instructed in the chapter "How to gain access to the control PCB". 3. Go to the next question.
2	Are the connections at the control PCB correct? ⁴	Yes	<ol style="list-style-type: none"> 1. Remove the heat exchanger as instructed in the chapter "Maintenance of the heat exchanger". 2. Access the mid-section sensor as instructed in the chapter "How to gain access to the mid-section sensor". 3. Go to the next question.
		No	<ol style="list-style-type: none"> 1. Reconnect the sensor connector. 2. Follow the procedure for ending the maintenance.
3	Is the connection at the sensor correct?	Yes	<ol style="list-style-type: none"> 1. Connect the power to the unit. <p> Risk of electrical shock.</p> <ol style="list-style-type: none"> 2. Stop the service mode as instructed in the chapter "How to change the operation mode of the unit". 3. Reset the errors as instructed in the chapter "How to reset errors". 4. Wait for 2 minutes. 5. Go to the next question.
		No	<ol style="list-style-type: none"> 1. Reconnect the sensor connector. 2. Follow the procedure for ending the maintenance.
4	Did the error come back?	Yes	<ol style="list-style-type: none"> 1. Disconnect the power from the unit. 2. Get the mid-section sensor service set. 3. Replace the sensor as instructed in its supplied manual. 4. Connect the power to the unit. <p> Risk of electrical shock.</p> <ol style="list-style-type: none"> 5. Reset the errors as instructed in the chapter "How to reset errors". 6. Wait for 2 minutes. 7. Go to the next question.
		No	<ol style="list-style-type: none"> 1. Disconnect the power from the unit. 2. Follow the procedure for ending the maintenance.
5	Did the error come back?	Yes	<ol style="list-style-type: none"> 1. Disconnect the power from the unit. 2. Get the control PCB service set. 3. Replace the control PCB as instructed in its supplied manual. 4. Follow the procedure for ending the maintenance. 5. Reset the errors as instructed in the chapter "How to reset errors".
		No	<ol style="list-style-type: none"> 1. Disconnect the power from the unit. 2. Follow the procedure for ending the maintenance.

Malfunction code SERVICE MODE.		The basic functions of the unit are stopped.	
	Question	Answer	Action
1	Are you performing any maintenance?	Yes	Ignore the error and continue the maintenance procedure.
		No	Go to the next question.
2	Is the standby switch connected to the option box closed?	Yes	Open the standby switch.
		No	Stop the SERVICE MODE.

⁴ You can find the correct connection in the technical specification chapter.

Malfunction code TEMPCONTROL_SUP ERROR			The modulating by-pass actuators have a malfunction.
	Question	Answer	Action
1	not applicable	not applicable	<ol style="list-style-type: none"> 1. Inspect the modulating by-pass valves as instructed in the chapter "Maintenance of the modulating by-pass valves". 2. Remove the modulating by-pass valves as instructed in the chapter "How to remove the modulating by-pass valve". 3. Go to the next question.
2	Are the connection joints of the valves clean?	Yes	<ol style="list-style-type: none"> 1. Connect the power to the unit. <p> Risk of electrical shock.</p> <ol style="list-style-type: none"> 2. Stop the service mode as instructed in the chapter "How to change the operation mode of the unit". 3. Open the modulating by-pass fully⁹. 4. Set the modulating by-pass back to its original setting⁹. 5. Go to the next question.
		No	<ol style="list-style-type: none"> 1. Clean the connection joints. 2. Follow the procedure for ending the maintenance. 3. Reset the errors as instructed in the chapter "How to reset errors".
3	Did the modulating by-pass actuators run?	Yes	<ol style="list-style-type: none"> 1. Set the modulating by-pass to the AUTO setting⁹. 2. Disconnect the power from the unit. 3. Follow the procedure for ending the maintenance. 4. Reset the errors as instructed in the chapter "How to reset errors".
		No	<ol style="list-style-type: none"> 1. Get the modulating by-pass actuator service set. 2. Replace the modulating by-pass actuator as instructed in its supplied manual. 3. Reset the errors as instructed in the chapter "How to reset errors".

Malfunction code TEMP_SENSOR_ETA ERROR / TEMP_SENSOR_ODA ERROR.			The extract / outdoor air sensor is detecting an incorrect temperature.
	Question	Answer	Action
1	Is the temperature between -40°C and +70°C	Yes	<ol style="list-style-type: none"> 1. Solve the problem for the extreme temperature. 2. Reset the errors as instructed in the chapter "How to reset errors". 3. Go to the next question.
		No	<ol style="list-style-type: none"> 1. Reset the errors as instructed in the chapter "How to reset errors". 2. Go to the next question.
2	Did the error come back?	Yes	<ol style="list-style-type: none"> 1. Inspect the heat exchanger as instructed in the chapter "Maintenance of the heat exchanger". 2. Follow the instructions of the SENSOR_ETA ERROR / SENSOR_ODA ERROR table.
		No	Inspect the heat exchanger as instructed in the chapter "Maintenance of the heat exchanger".

Malfunction code TEMP_SENSOR_EHA ERROR / TEMP_SENSOR_SUP ERROR.			The extract / outdoor air sensor is detecting an incorrect temperature.
	Question	Answer	Action
1	Is the temperature between -40°C and +70°C	Yes	<ol style="list-style-type: none"> 1. Solve the problem for the extreme temperature. 2. Reset the errors as instructed in the chapter "How to reset errors". 3. Go to the next question.
		No	<ol style="list-style-type: none"> 1. Reset the errors as instructed in the chapter "How to reset errors". 2. Go to the next question.
2	Did the error come back?	Yes	<ol style="list-style-type: none"> 1. Inspect the heat exchanger as instructed in the chapter "Maintenance of the heat exchanger". 2. Follow the instructions of the SENSOR_EHA ERROR / SENSOR_SUP ERROR table.
		No	Inspect the heat exchanger as instructed in the chapter "Maintenance of the heat exchanger".

⁹ You can find the modulating by-pass settings in menu
> MENU > TASK MENU > BYPASS

9.15 What to do in the event of a malfunction (or problem) without a malfunction alert (troubleshooting)

Problem:			The display and fans of the unit are off.
	Question	Answer	Action
1	Is the mains power connected?	Yes	1. Open the semi-transparent visor. 2. Pull the cable tray cover forwards. 3. Go to the next question.
		No	Connect the mains power.
2	Is the power cable connected? (Check unit side and wall side)	Yes	1. Access the control PCB as instructed in the chapter "How to gain access to the control PCB". 2. Go to the next question.
		No	Connect the power cable.
3	Is a power signal present (230VAC) on the control PCB?	Yes	1. Get the control PCB service set. 2. Replace the control PCB as instructed in its supplied manual.
		No	Replace the power cable.

Problem:			The supply temperature is high in the summer.
	Question	Answer	Action
1	Is the modulating by-pass function set to DISABLE? ⁹	Yes	Set the modulating by-pass function to AUTO or OPEN. ⁹
		No	Go to the next question.
2	Is the unit in heating season? ¹⁰	Yes	Set the limit RMOT (average outside temperature over 5 days) heat to the correct value. ¹⁰
		No	Decrease the temperature profile. ¹¹

Problem:			The supply temperature is low in the winter.
	Question	Answer	Action
1	Is the modulating by-pass function set to OPEN? ⁹	Yes	Set the modulating by-pass function to AUTO or DISABLE. ⁹
		No	Go to the next question.
2	Is the unit in cooling season? ¹⁰	Yes	Set the limit RMOT (average outside temperature over 5 days) cool to the correct value. ¹⁰
		No	Increase the temperature profile. ¹¹

Problem:			The unit will not turn on
	Question	Answer	Action
1	Is the power supply of the unit connected?	Yes	Go to the next question.
		No	Connect the power supply of the unit
2	Is something wrong with the power cable?	Yes	Replace the cable.
		No	Go to the next question.
3	Is the power in the fuse box turned on?	Yes	Go to the next question.
		No	Turn the power in the fuse box on.
4	Do you have power in the rest of the dwelling?	Yes	1. If the unit is a ComfoAir Q 350 get a F5010 fuse. Otherwise get a F5015 fuse. 2. Access the main power fuse as instructed in the chapter "How to gain access to the main power fuse of the unit". 3. Replace the main power fuse of the unit.
		No	Call your power supplier to report a power out.

⁹ You can find the modulating by-pass settings in menu
> MENU > TASK MENU > BYPASS

¹⁰ You can find the current season and the RMOT heat settings in menu
> MENU > STATUS > SEASON DETECTION > SEASON

¹¹ You can find the temperature profile setting in menu
> MENU > TASK MENU > TEMPERATURE PROFILE

Problem:			There is too much noise.
	Question	Answer	Action
1	Is the noise a whistling noise?	Yes	Locate the air gap and seal it.
		No	Go to the next question.
2	Is the noise a slurping noise?	Yes	1. Check the condensation drain. 2. Go to the next question.
		No	Go to question 4.
3	Has the condensation drain been connected properly?	Yes	Fill the condensation drain.
		No	Reconnect the condensation drain.
4	Is the noise an airflow noise?	Yes	1. Check the valves and/or grilles. 2. Check the filters 3. Go to the next question.
		No	1. Open the fans as instructed in the chapter "Maintenance of the fans". 2. Skip the next question.
5	Do the valves and/or grilles seal onto the air ducts?	Yes	1. Regulate the valves and/or grilles to the required airflow per room. ¹² 2. Inform the residents about the importance of the valve and/or grille settings.
		No	Reinstall the valves and/or grilles.
6	Are the fan bearings damaged?	Yes	1. Get the fan service set. 2. Replace the fan as instructed in its supplied manual.
		No	Set the preset airflow levels lower.







Problem:			There is a water (condensation) leak.
	Question	Answer	Action
1	Does the condensation from the exhaust air duct run into the unit?	Yes	Go to the next question.
		No	Reconnect the exhaust air duct.
2	Is the condensation drain connected correct?	Yes	Clean the condensation drain as instructed in the chapter "Maintenance of the condensation drain".
		No	Reconnect the condensation drain.

Problem:			The ancillary is not working.
	Question	Answer	Action
1	Does the ancillary have a battery?	Yes	Check the battery and replace it when necessary as instructed in its supplied manual.
		No	Go to the next question.
2	Is the ancillary commissioned to the unit?	Yes	Go to the next question.
		No	Commission the ancillary as instructed in its supplied manual.
3	Does the ancillary send a signal when in use?	Yes	Go to the next question.
		No	1. Get a new ancillary. 2. Replace the ancillary.
4	Is the ancillary connected to an option box?	Yes	Go to the next question.
		No	1. Get the control PCB service set. 2. Replace the control PCB as instructed in its supplied manual.
5	Does the option box send a signal when the ancillary is in use?	Yes	1. Get the control PCB service set. 2. Replace the control PCB as instructed in its supplied manual.
		No	1. Get a new option box. 2. Replace the option box.

Problem:			The correct time is not saved after a power down.
Action			
1. Get a 3V lithium button cell battery with a nominal capacity of 48 mAh. (Type BR1225)			
2. Access the control PCB as instructed in the chapter "How to gain access to the control PCB".			
3. Replace the battery on the control PCB.			

¹² Use a flow meter to set the valves and/or grilles into the correct position.

10 Available operating devices

Appearance Example	Name	Remark
	Zehnder ComfoSense C 67	You can connect the ComfoSense C directly to the unit via a ComfoNet connection.
	Zehnder ComfoSwitch C 67	You can connect the ComfoSwitch C directly to the unit via a ComfoNet connection.
	Zehnder Control App	The Control App is available for Android and IOS devices. An installed ComfoConnect LAN C is necessary to translate the signal from the Control App.
	Zehnder Timer RF	A connected ComfoSense C is necessary to translate the signal from the Timer RF.
	Zehnder CO ₂ sensor	A connected option box is necessary to translate the signal from the CO ₂ sensor.
	Bathroom switch	A connected option box is necessary to translate the signal from the bathroom switch.

11 Optional ancillaries

Appearance Example	Name	Remark
	Zehnder ComfoFond-L Q	A connected option box is necessary to control the ComfoFond-L Q.
	Zehnder ComfoCool Q600	You can connect the ComfoCool Q600 directly to the unit via a ComfoNet connection.
	Zehnder ComfoAir Q pre-heater	You can install the pre-heater on site into the unit.
	Zehnder Option box	You can connect the option box directly to the unit via a ComfoNet connection. The option box will give additional connectivity options. For example: <ul style="list-style-type: none"> ■ One additional ComfoNet RJ45 connection; ■ Two additional ComfoNet plug-in connections; ■ One 0-10V output connection; ■ Four 0-10V input connections.
	Zehnder ComfoConnect KNX C	You can connect a ComfoConnect KNX C directly to the unit via a ComfoNet connection.
	Zehnder ComfoConnect LAN C	You can connect a ComfoConnect LAN C directly to the unit via a ComfoNet connection. The Zehnder ComfoConnect LAN C is also available in a Wi-Fi KIT version.
	Standby switch	A connected option box is necessary to translate the signal from the standby switch.
	Error contact	A connected option box is necessary to transmit an error signal.
	External filter	You can connect a filter error sensor to the option box of the unit (external filter error contact).
	Post-heater	A connected option box is necessary to control the post-heater.
	Unregulated sub-soil heat exchanger	The unit can only control the Zehnder sub-soil heat exchanger called ComfoFond-L Q. When a different controlled sub-soil heat exchanger is necessary, the sub-soil heat exchanger must have its own control system.
	Extractor hood (non powered)	<p>⚠ Never install a <u>powered</u> extractor hood on the same ducting as the unit. This will compromise the performance of the system.</p> <p>Install at least 3m of air duct between the extractor hood and the unit. This will protect the heat exchanger from the dirt removed by the extractor hood.</p>







Quick Installation Guide
 Please refer to the full installation manual for detailed
 installation and commissioning information.

Legend:

Code	Meaning
R	Supply and extract air to the right side
L	Supply and extract air to the left side
ERV	Enthalpy exchanger installed
ODA	Outdoor air
SUP	Supply air
ETA	Extract air
EHA	Exhaust air

