

Heating

Cooling

Fresh Air

Clean Air





Foreword

Read this document carefully before use.

With this document you can commission and perform the maintenance of the ComfoAir Q in a safe and optimal manner. In this document the ComfoAir Q will be referred to as “the unit”. The unit is subject to continuous development and improvement. Thus the unit may be slightly different from the given descriptions.

The following pictograms are used in the Zehnder documents:

Symbol	Meaning
	Point of interest.
	Risk of compromised performance or damage of the ventilation system.
	Risk of personal injury.

Information found in the user manual

General information about the ventilation system.
Warranty and liability conditions.
EEC declaration of conformity.
How to replace the filters in the unit.
How to clean the valves and/or grilles in the ventilation system.
How to use the display on the unit.

Information found in the installer manual

Installation conditions
Information about transport and unpacking
Installation procedures
Available operating devices
Available ancillaries

Information found on the identification plate

Suffix	Meaning
ComfoAir	Product family name.
Q	Product type name.
350	Maximum air volume of 350 m ³ /h.
450	Maximum air volume of 450 m ³ /h.
600	Maximum air volume of 600 m ³ /h.
GB	Country code of the unit.
R	The unit has been set with the supply and extract air on the right side as default.
L	The unit has been set with the supply and extract air on the left side as default.
ST	The unit has four fixed air connections.
PH	The unit has a pre-heater installed as default.
ERV	The unit has an enthalpy exchanger installed as default.

! ? Questions

Contact your supplier when you have any questions or would like to order a new document or new filters. The contact details of the main supplier can be found on the back page of this document.

All rights reserved.

This documentation has been made with the utmost care. The publisher cannot be held liable for any damage caused as a result of missing or incorrect information in this document. In case of disputes the English version of the instructions will be binding.

Table of Contents

	Foreword.....	2
1	Safety instructions	5
2	Technical specifications	6
	2.1 Overview of the unit.....	10
	2.2 Service parts	11
	2.3 Wiring diagram main board.....	12
3	Commissioning procedure.....	13
	3.1 Commissioning the unit.....	13
	3.2 Programming the RF controls	15
4	Operation.....	16
	4.1 Access the unit display	16
	4.2 Overview of the unit display.....	16
	4.3 Activate/deactivate the child lock	18
	4.4 How to navigate through the unit menu	18
	4.5 Access the installer settings	18
	4.6 Menu structure.....	19
	4.7 COMMISSIONING menu.....	21
	4.8 MAIN BOARD SETTINGS menu.....	23
	4.8.1 VENTILATION PRESETS menu	23
	4.8.2 VENTILATION CONTROLS menu.....	23
	4.8.3 FILTER SETTINGS menu.....	23
	4.8.4 ALTITUDE menu.....	23
	4.8.5 FIRE PLACE PRESENT menu	23
	4.8.6 UNBALANCE menu.....	24
	4.8.7 HEAT EXCHANGER TYPE menu.....	24
	4.8.8 DIRECT FAN CONTROL menu	24
	4.8.9 SERVICE MODE menu	24
	4.9 OPTION BOX SETTINGS ³ menu	24
	4.10 LOG OUT menu	24
	4.11 Reset options.....	24
	4.12 Software update.....	24

³ This menu is only visible when the accessory is connected to the unit.

5	Maintenance procedures.....	25
5.1	Procedure for opening the unit	25
5.2	Maintenance of the casing	26
5.3	Maintenance of the heat exchanger	26
5.4	Maintenance of the fans.....	27
5.5	Maintenance of the modulating bypass valves	28
5.6	Maintenance of the pre-heater.....	28
5.7	Maintenance of the condensation drain.....	29
5.8	Maintenance of the air ducts	29
5.9	Procedure for ending the maintenance.....	30
6.	Malfunction procedures	30
6.1	How to reset errors.....	30
6.2	How to remove ancillaries.....	31
6.3	Malfunction alerts on the display of the unit ¹	31
6.4	How to gain access to the ComfoNet connectors on the unit.....	32
6.5	How to gain access to the main board	32
6.6	How to gain access to the main power fuse of the unit	32
6.7	How to gain access to the top-section sensor	33
6.8	How to gain access to the mid-section sensor.....	33
6.9	How to remove the modulating bypass valve	34
6.10	How to change the location of the pre-heater	34
6.11	What to do in the event of a malfunction alert (troubleshooting).....	35
6.12	What to do in the event of a malfunction (or problem) without a malfunction alert (troubleshooting).....	42

1 Safety instructions

- Always obey the safety regulations, warnings, comments and instructions given in this document. When the safety regulations, warnings, comments and instructions in this document are not obeyed personal injury or damage to the unit can occur;
- Always obey the general and locally applicable construction, safety and installation instructions of the local council, electricity and water boards or other agencies;
- Always connect air ducts of at least 900mm to the unit before you connect the power to the unit. This ensures the motor cannot be touched while the unit is active;
- After installation all parts that can cause personal injury are secured behind the casing. Tools are required to open the casing;
- The installation, commissioning and maintenance must be carried out by a certified engineer unless instructed differently. A non-certified engineer can cause personal injury or damage the performance of the ventilation system;
- Do not modify the unit or the specifications given in this document. A modification can cause personal injury or damage the performance of the ventilation system;
- Always disconnect all poles of the power supply to the unit and optional connected ComfoSplitter before you start working on the ventilation system. The unit can cause personal injury when it is open while running. Make sure the unit cannot switch back on by accident;
- Often power is needed on the unit during troubleshooting while the unit is open. At all times be aware of the danger for electrical shocks and rotating parts. Therefore always take all the possible precautions to protect yourself and others during troubleshooting.

- Always take ESD-inhibiting measures when dealing with electronics, such as wearing an antistatic wristband. The electronics can be damaged by static charges;



- The FIREPLACE setting is not a safety feature. For safety, a delta-pressure switch switching off the ventilation in case of under pressure should still be installed;
- Do not change the filters when the unit is powered without using the filter wizard. For safety reasons the unit will stop ventilating during the filter replacement instructions.



2 Technical specifications

	Q 350		Q 450		Q 600	
Performance						
Minimal airflow when preheater is off	75m ³ /h		75m ³ /h		75m ³ /h	
Minimal airflow when preheater is on	100m ³ /h		100m ³ /h		100m ³ /h	
Maximal airflow	350m ³ /h		450m ³ /h		600m ³ /h	
Thermal Efficiency (According to EN 13141-7:2010)	92%		90%		89%	
Electrical data						
Maximal power including pre-heater (At -15°C and max airflow)	1850W	10.00A	2240W	10.80A	2620W	12.70A
Maximal power excluding pre-heater	180W	1.42A	250W	1.98A	350W	2.77A
Power Supply	230V±10%, single phase, 50Hz					
Cos φ	0.36 - 0.54		0.32 - 0.57		0.4 - 0.62	
Internal fuse	F5010 (10A)		F5015 (16A)		F5015 (16A)	
Connection data						
Air connection size (Ø)	Inside: 160mm Outside: 190mm		Inside: 180mm Outside: 200mm		Inside: 180mm Outside: 200mm	
Condensation drain size (Ø)	Tube version: 32mm Thread version: 1¼"					
ComfoNet data						
Maximal power	400mA@12V					
Maximal non powered devices	4					
Cable type	2x unshielded twisted pair, stiff (solid) wires 0,6mm ² (max 50m)					
Colour code	12V: red GND: black CAN_H: yellow CAN_L: white					
						
Material specifications						
Housing	Coated Sheet Steel					
Interior	EPP and ABS					
Heat Exchanger	Polystyrene					
Enthalpy Exchanger	Polyethylene-polyether-copolymer					
General						
IP classification	IP40					
ISO classification	B					
Temperature range during transport and storage	-40°C tot +60°C					
Temperature range moved air	-20°C tot +60°C					
Temperature range installation area	0°C tot 45°C					
Relative air humidity installation area	<90%; non-condensing					
Weight	50kg					
Filter class	Outdoor air: G4 / F7 Extract air: G4					

ComfoAir Q 350

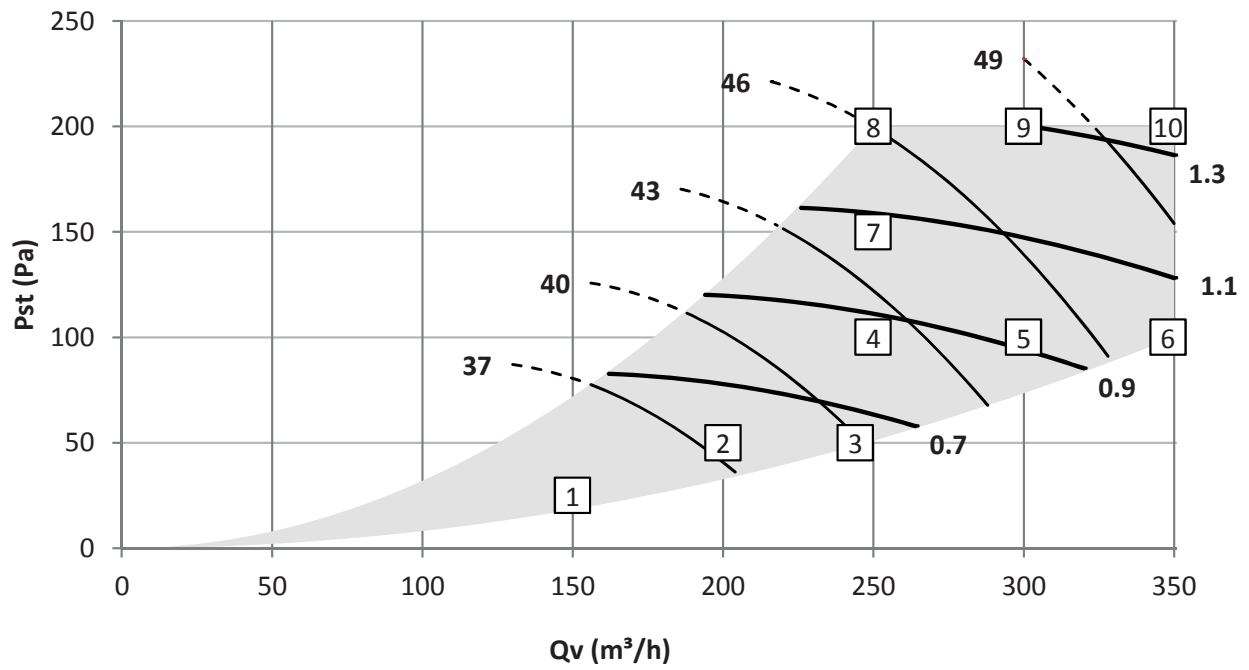

Recommended working point
 SFP (W/l/s)
 Lw (dB[A])

	Qv m³/h	Pst Pa	P W	cos φ -	SFP Wh/l/s	Lw, supply dB(A)	Lw, extract dB(A)	Lw, casing dB(A)
1	150	25	16	0.41	0.37	46	34	33
2	200	50	31	0.45	0.57	51	38	37
3	245	50	43	0.47	0.64	54	40	40
4	250	100	59	0.49	0.85	56	42	42
5	300	100	77	0.50	0.92	59	45	45
6	350	100	98	0.51	1.00	63	48	47
7	250	150	74	0.50	1.06	59	44	44
8	250	200	88	0.51	1.27	61	46	46
9	300	200	108	0.52	1.30	63	48	48
10	350	200	131	0.53	1.35	66	50	50

Lw in dB(A) reference $10^{-12}W$

Casing radiation measured according to ISO 3741:2010

Supply noise and extract noise measured according ISO 5135:1997 (values include end duct correction)

SFP calculated using data measured according EN13141-7:2010

cos phi with pre heater switched off (if present)

ComfoAir Q 450

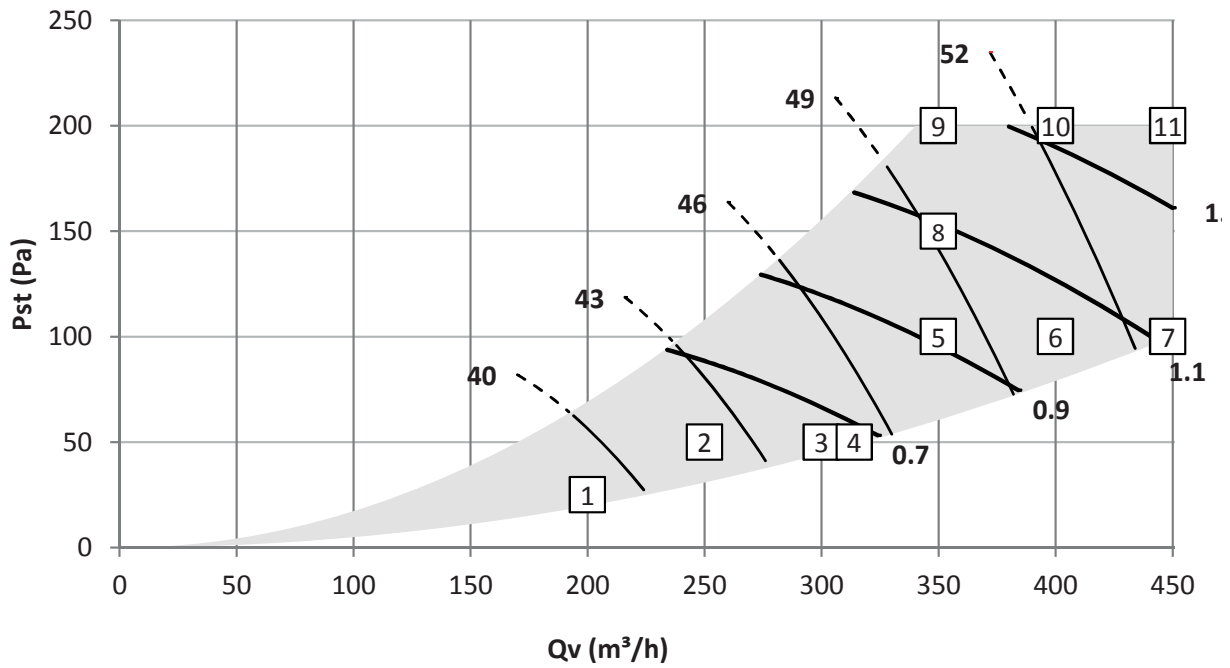

Recommended working point

 SFP (W/l/s)

 Lw (dB[A])

	Qv m³/h	Pst Pa	P W	cos φ	SFP Wh/l/s	Lw, supply dB(A)	Lw, extract dB(A)	Lw, casing dB(A)
1	200	25	19	0.40	0.33	51	40	39
2	250	50	37	0.46	0.54	54	43	42
3	300	50	53	0.48	0.64	57	45	44
4	315	50	59	0.49	0.67	57	46	45
5	350	100	89	0.52	0.92	61	48	48
6	400	100	113	0.54	1.01	63	50	50
7	450	100	140	0.55	1.12	66	52	53
8	350	150	106	0.53	1.09	62	49	49
9	350	200	122	0.54	1.26	63	50	50
10	400	200	148	0.55	1.33	65	52	52
11	450	200	177	0.57	1.42	68	54	54

Lw in dB(A) reference 10^{-12} W

Casing radiation measured according to ISO 3741:2010

Supply noise and extract noise measured according to ISO 5135:1997 (values include end duct correction)

SFP calculated using data measured according to EN13141-7:2010

cos phi with pre heater switched off (if present)



When the automated bypass control is active the maximum air flow is restricted.

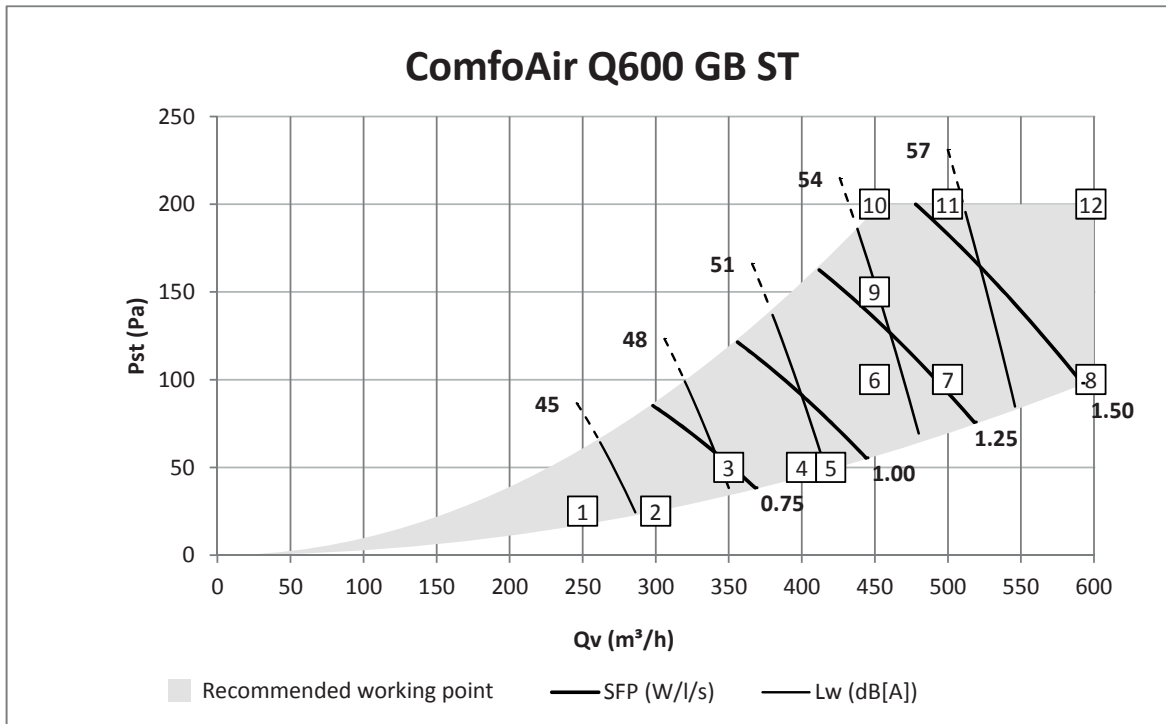

	Qv m³/h	Pst Pa	P W	cos φ -	SFP Wh/l/s	Lw, supply dB(A)	Lw, extract dB(A)	Lw, casing dB(A)
1	250	25	28	0.48	0.40	54	43	43
2	300	25	44	0.51	0.53	56	45	45
3	350	50	72	0.54	0.74	59	48	48
4	400	50	97	0.55	0.87	62	50	50
5	420	50	107	0.56	0.92	63	51	51
6	450	100	143	0.57	1.15	65	53	53
7	500	100	176	0.59	1.27	68	55	55
8	600	100	254	0.61	1.53	73	59	60
9	450	150	162	0.58	1.29	66	53	54
10	450	200	180	0.59	1.44	67	54	55
11	500	200	215	0.60	1.55	70	56	57
12	600	200	296	0.61	1.77	75	60	61

Lw in dB(A) reference 10⁻¹²W

Casing radiation measured according to ISO 3741:2010

Supply noise and extract noise measured according ISO 5135:1997 (values include end duct correction)

SFP calculated using data measured according EN13141-7:2010

cos phi with pre heater switched off (if present)

When the automated bypass control is active the maximum air flow is restricted.

2.1 Overview of the unit

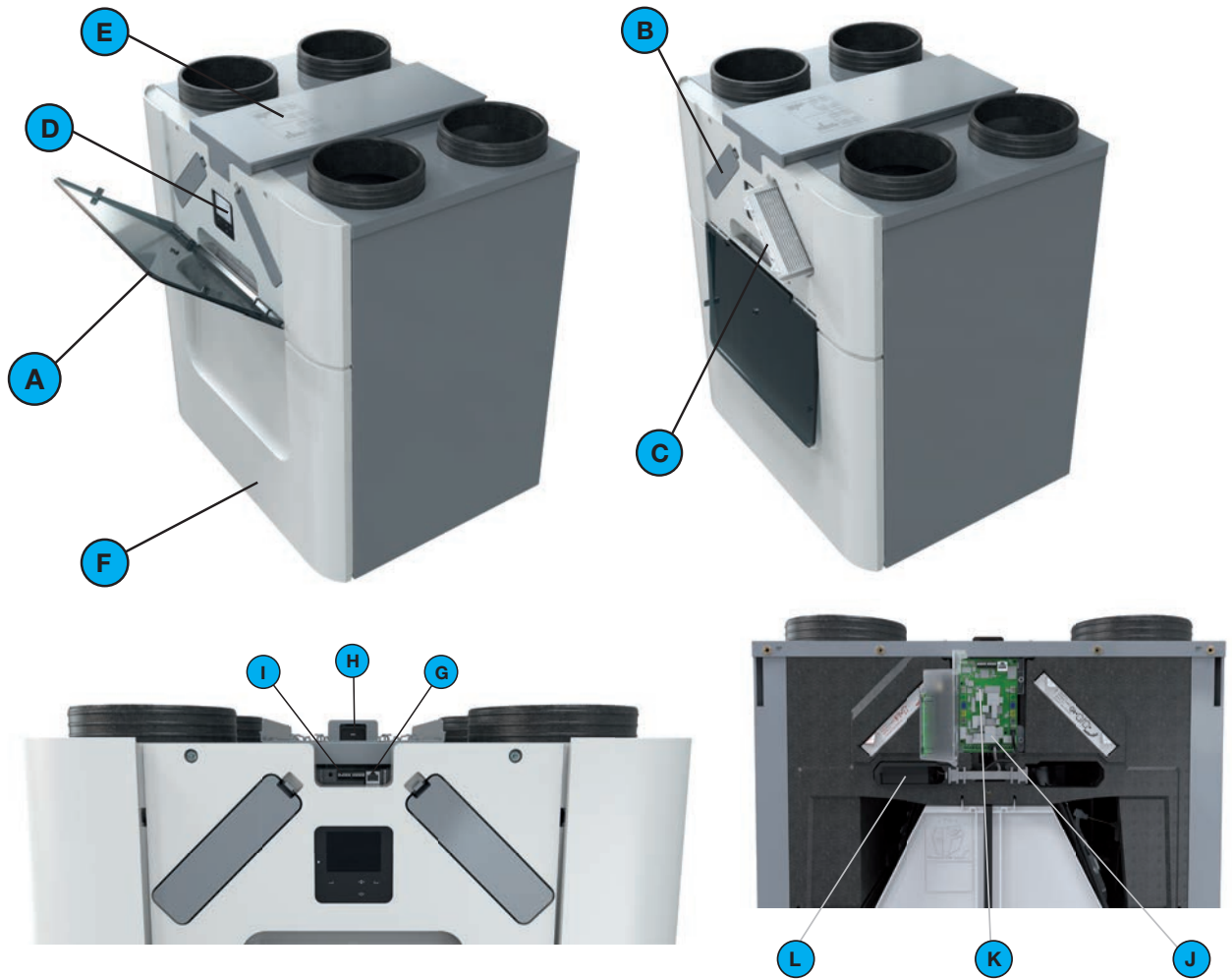

Position	Part
A	Semi-transparent visor for access to the display and the filter caps.
B	2 filter caps for easy access to the filters.
C	2 filters for air filtering.
D	Display to operate the unit.
E	Cable tray cover for cover and protection of the connected cables.
F	Front cover for an air tight seal.
G	ComfoNet RJ45 connection.
H	Mains power connection and identification plate detailing information on the unit (not visible).
I	2 ComfoNet plug-in connections.
J	Main board behind the display cover.
K	RF PCB on the main board
L	Pre-heater for frost protection. (optional; standard in unit version "VV")

2.2 Service parts

The service parts mentioned below can be ordered as a special service set from Zehnder. Each set will be supplied with its own service instruction explaining how to replace the part. Please check the pricelist of the supplier for the article codes and prices of all available sets.

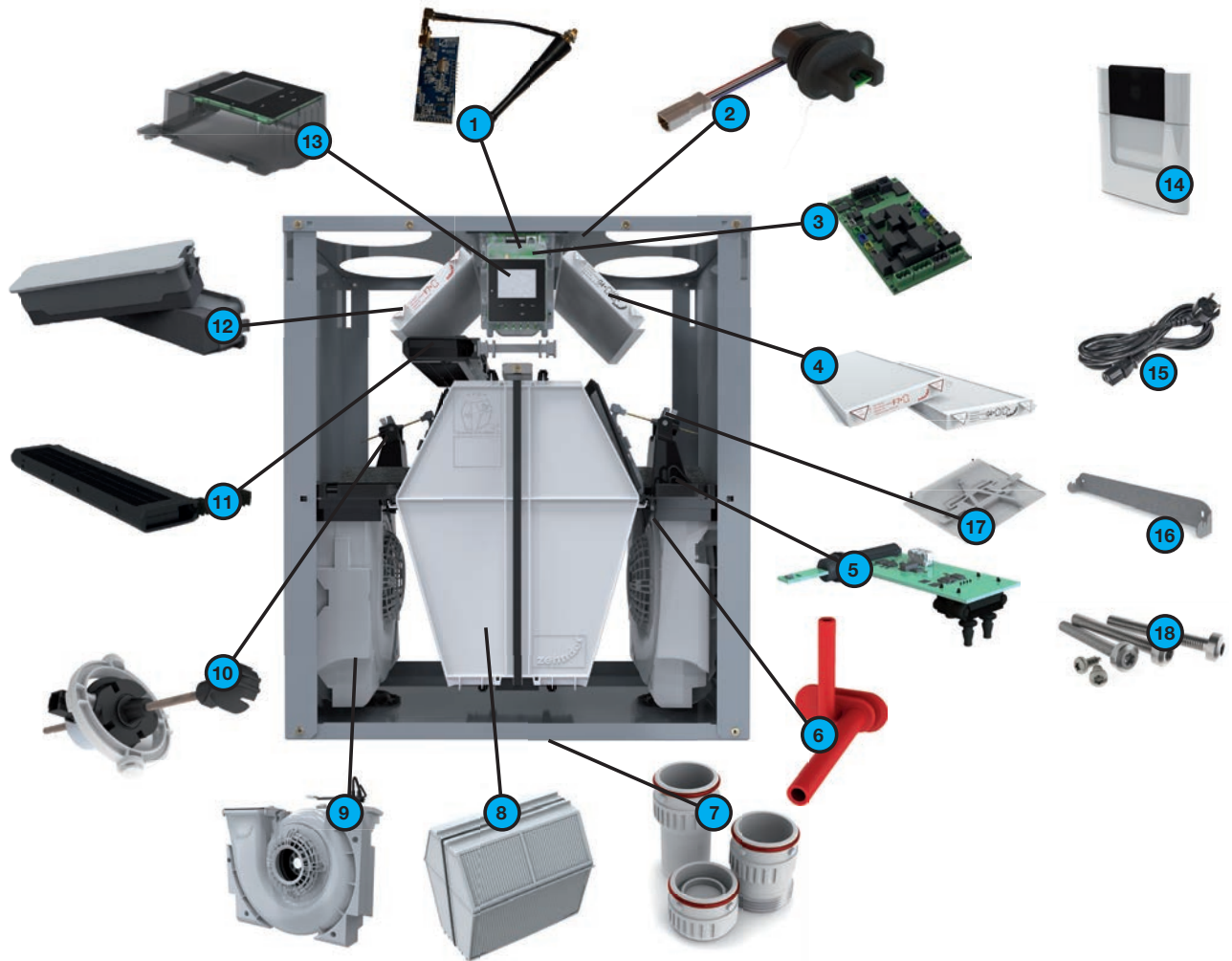

Position	Part
1	RF PCB
2	Top-section sensor
3	Main board
4	Filter set G4/G4 (1x/1x) Filter set G4/F7 (1x/1x)
5	Mid-section sensor
6	Fan pressure hoses
7	Drain set
8	Heat exchanger Enthalpy exchanger
9	Fan
10	Modulating bypass actuator
11	Pre-heater
12	Filter cap set (2x)
13	Display
14	Front cover
15	Power cord
16	Mounting bracket
17	Modulating bypass valve
18	Screws

2.3 Wiring diagram main board

Legend:



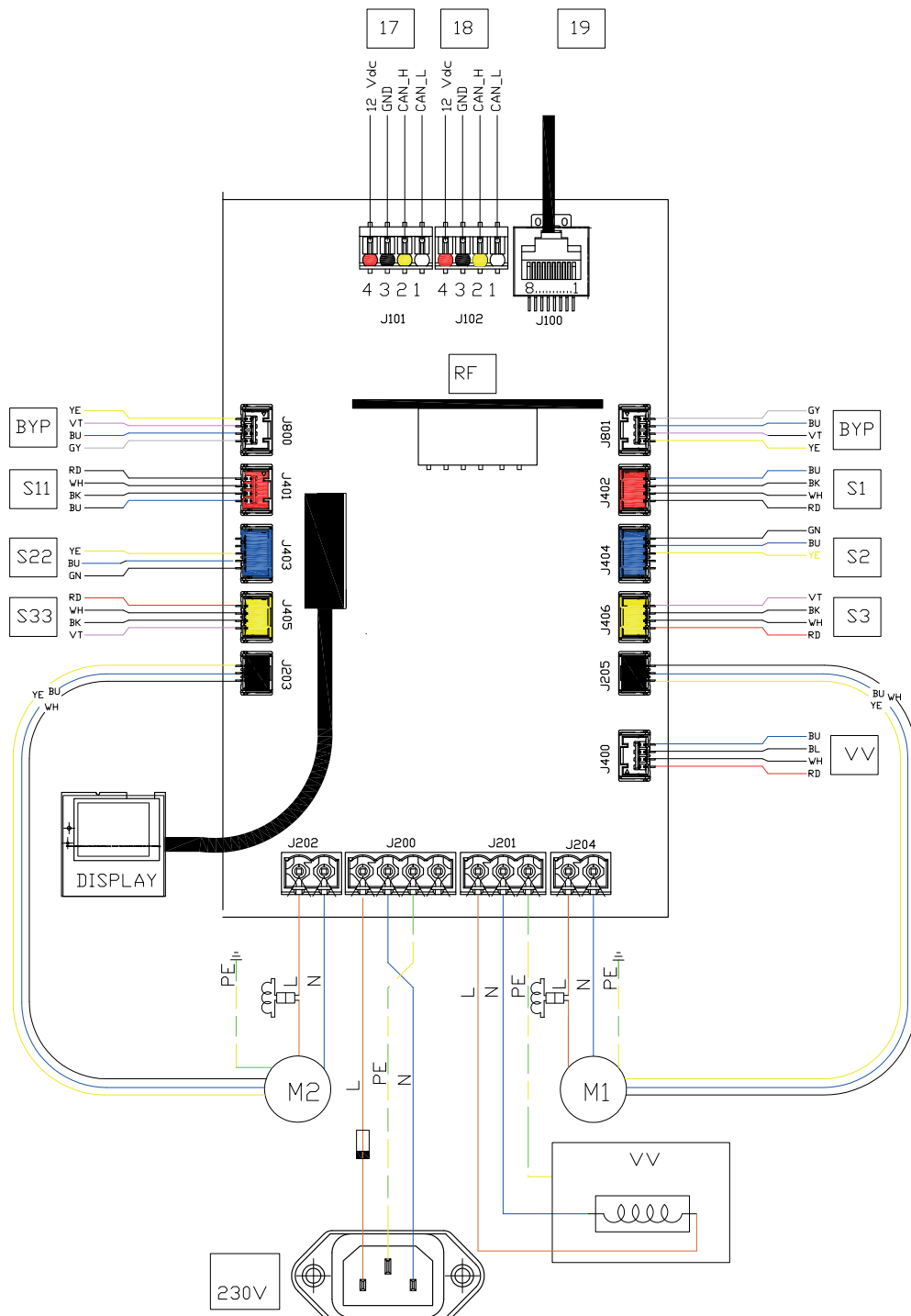



Code	Meaning	Meaning		
		Orientation: Right	Orientation: Left	
PE	Green / Yellow	DISPLAY	Display screen	Display screen
N / BU	Blue	RF	Not applicable	Not applicable
L / BK	Brown or Black	VV	Pre-heater	Pre-heater
WH	White	BYP	Modulating bypass actuator	Modulating bypass actuator
RD	Red	M1	Exhaust motor	Supply motor
GN	Green	M2	Supply motor	Exhaust motor
YE	Yellow	S1	Sensor outdoor air	Sensor extract air
GY	Grey	S2	Exhaust air pressure sensor	Supply air pressure sensor
VT	Violet	S3	Sensor supply air	Sensor exhaust air
17 / 18	ComfoNet plug-in	S11	Sensor extract air	Sensor outdoor air
19	Not applicable	S22	Supply air pressure sensor	Exhaust air pressure sensor
		S33	Sensor exhaust air	Sensor supply air









3 Commissioning procedure

3.1 Commissioning the unit

Zehnder recommends cleaning the air ducts before commissioning the unit if the dwelling is occupied. This will prevent damage to the furniture from building dust being blown out of the air ducts.

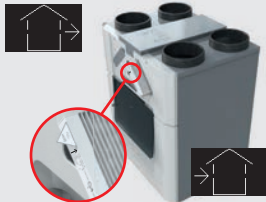
<p>1</p> 	<p>2</p> 	<p>3</p> 
<p>Connect the power to the unit.</p> <p>! Run the first part (basic configuration) of the commissioning wizard immediately after turning on the power. These settings are necessary to protect the unit from frost and water damage.</p>	<p>Open the semi-transparent visor.</p>	<p>The unit will automatically start up the commissioning wizard. Follow the instructions on the display.</p>
<p>4</p> <p>Example ancillaries</p> 	<p>5</p> 	<p>6</p> <p>Example report</p> 
<p>Commission all connected ancillaries as instructed in their corresponding manuals.</p> <p>! The commission procedure for the RF ancillaries is different from the older Zehnder units.</p>	<p>It would be beneficial to the end user if the advanced user menu options were also setup during the commissioning procedure, for example the SENSOR VENTILATION settings. Information on how to set these can be found within the user manual.</p>	<p>Fill in the installation/test report in the back of the user manual.</p>

Attention point commissioning wizard

<p style="text-align: center;">1</p> 	<p style="text-align: center;">2</p>  <p style="text-align: center;">Right Left</p>	<p style="text-align: center;">3</p> <p style="text-align: center;">Example siphon</p> 
<p>Please contact Zehnder for the password to gain access to the installer settings.</p>	<ul style="list-style-type: none"> ■ Right = The supply and extract air are on the right side of the unit; ■ Left = The supply and extract air are on the left side of the unit. 	<p>When the unit has a standard heat exchanger a dry siphon must always be present.</p>
<p style="text-align: center;">4</p>  <p style="text-align: center;">Left</p>	<p style="text-align: center;">5</p> 	<p style="text-align: center;">6</p> <p style="text-align: center;">Example flow meter</p> 
<p>When the orientation of the unit is LEFT the location of the filters should be:</p> <ul style="list-style-type: none"> ■  = Left side; ■  = Right side. <p>Make sure the arrow on the filters are pointing upwards.</p> <p>When the supply and extract air filters are the same, there is no need to switch the filters as instructed by the unit.</p>	<p>When opening all valves/grilles also close all windows and doors.</p>	<p>Use a flow meter to set the valves and/or grilles into the correct position during fine tuning.</p>

3.2 Programming the RF controls

To enable the use of RF controls, the unit must be fitted with a ComfoSense C.

1

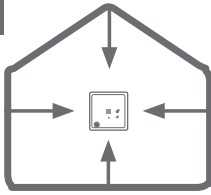

Locate the RF control(s) and the unit so that there are no large metal objects between them.

<p>2</p>	<p>3</p>	<p>4</p>
<p>Set the desired settings for all the RF-signals in the ADVANCED user menu:</p> <ol style="list-style-type: none"> If needed: Activate ADVANCED MODE. <ul style="list-style-type: none"> Select SHIFT Select ADVANCED Navigate to ADVANCED SETTINGS Navigate to RF SETTINGS 	<p>Navigate to menu START on the ComfoSense C display:</p> <ol style="list-style-type: none"> Navigate to the ADVANCED SETTINGS menu. <ul style="list-style-type: none"> Press OK. Press MENU before the text SHIFT disappears. Navigate to the RF PAIRING menu. <p>You have 10 minutes time to commission one RF device.</p>	<p>Press the button "10 min." & button "Timer OFF" together for at least 6 sec.</p>
<p>5</p>		
<p>Test the control after programming.</p>	<p>If the units air flow rate is changed following the test (see the unit's display for confirmation) then registration of the controller has been successful.</p> <p>If the units air flow rate isn't changed following the test (see the unit's display for confirmation) then registration of the controller has been unsuccessful. Please return to step 2 and try again.</p>	



Each RF control must be registered separately. So for each extra RF control, return to step 2.

4 Operation

You can find a complete explanation about how to use the unit display in the user manual. In this chapter you can find the basic information needed to commission and maintain the unit.

4.1 Access the unit display

To save energy the unit display screen will be off most of the time. The display will automatically turn off after 15 minutes of no activity. The following actions will make the screen visible:

- Open the semi-transparent visor;
- Press any key on the display.



4.2 Overview of the unit display

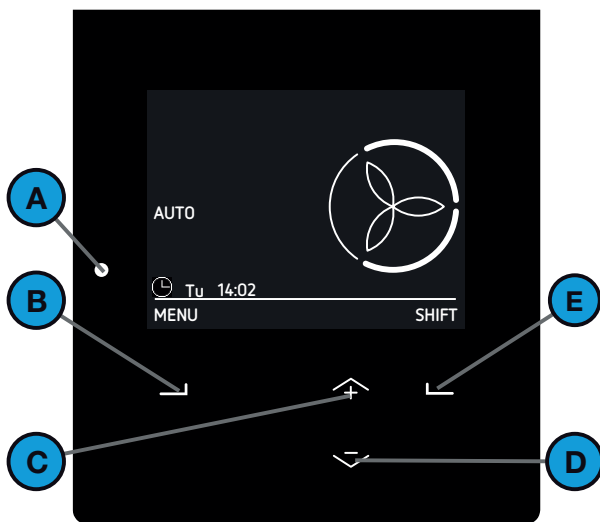

Position	Part
A	Status indicator LED light. <ul style="list-style-type: none">■ On = The unit is operating correctly;■ Off = The unit has no power or the display is in use;■ Slowly flashing (every second) = Warning (Change filters or SERVICE MODE active);■ Rapidly flashing (four times a second) = Error.
B	Universal button. The function depends on the current text on the display.
C	Up button to: <ul style="list-style-type: none">■ Increase preset;■ Increase value;■ Select the previous item.
D	Down button to: <ul style="list-style-type: none">■ Decrease preset;■ Decrease value;■ Select the next item.
E	Universal button. The function depends on the current text on the display.

There are two user modes available on the unit:

- The basic mode provides access to general settings and information on the main screen and in the menu screen.

The symbol  is displayed in the left top corner of the menus when the basic mode is active.





- The advanced mode provides access to more detailed information on the main screen and in the menu screen.



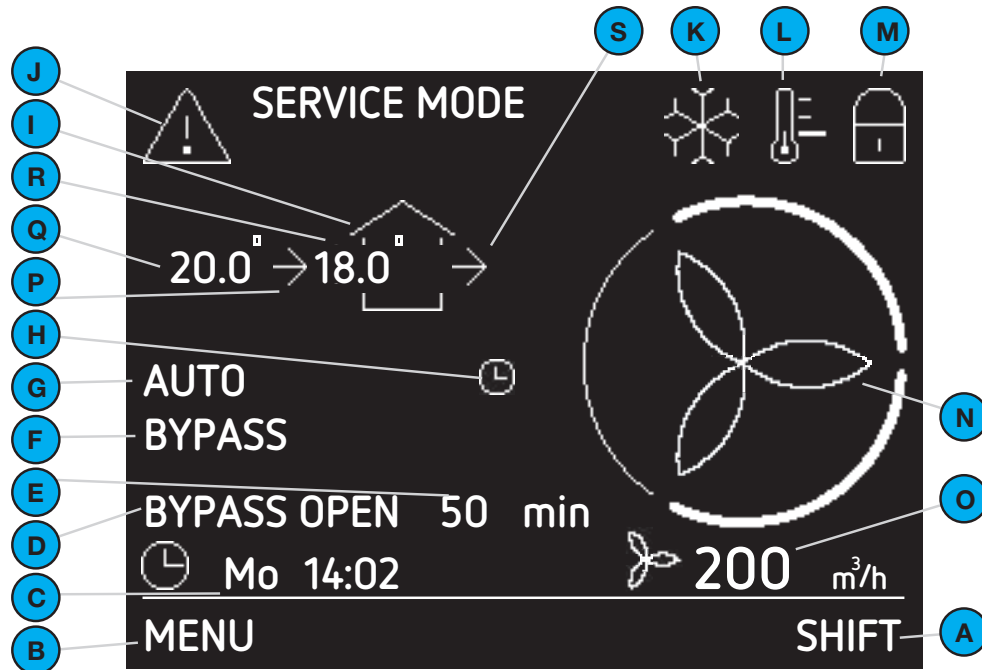





All information from the basic mode is also accessible in the advanced mode.

The symbol  is displayed in the left top corner of the menus when the advanced mode is active.

Overview Main screen



Position	Part
A	Current function of the universal button below it.
B	Current function of the universal button below it.
C	Current day and time.
D	Current operating function.
E	Remaining time of current operating function.
F	Current active automated control.
G	Current ventilation mode: <ul style="list-style-type: none"> ■ AUTO = the airflow is set by the scheduler; ■ MANUAL = the airflow is set by the user.
H	Temporary override of the SCHEDULER VENTILATION.
I	Current fan mode: <ul style="list-style-type: none"> ■ no icon = both fans are in operation (BALANCE); ■  = extract fan is not in operation (SUPPLY ONLY); ■  = supply fan is not in operation (EXTRACT ONLY); ■  = both fans are not in operation
J	Current warning or error message: <ul style="list-style-type: none"> ■  = Warning; ■  = Error.
K	ComfoCool Q600 is in operation.

Position	Part
L	Current set temperature profile: <ul style="list-style-type: none"> ■ no icon = NORMAL. ■  = WARM; ■  = COOL.
M	Child lock is in operation.
N	Current set airflow: <ul style="list-style-type: none"> ■  = PRESET A (Away) ■  = PRESET 1 (Low) ■  = PRESET 2 (Middle) ■  = PRESET 3 (High) <p>When an automated control requires more airflow than requested the extra airflow segment is blinking.</p>
Only available in advanced mode	
O	Current airflow volume in m³/h or l/s.
P	Current supply fan mode: <ul style="list-style-type: none"> ■ no icon = fan is not in operation; ■  = fan is in operation.
Q	Current outdoor air temperature in °C or °F. (Only visible when the supply fan is active)
R	Current supply air temperature °C or °F. (Only visible when the supply fan is active)
S	Current extract fan mode: <ul style="list-style-type: none"> ■ no icon = fan is not in operation; ■  = fan is in operation.

4.3 Activate/deactivate the child lock

To prevent unwanted changes to the settings, the unit display is equipped with a child lock. As long as the child lock is enabled the symbol  is visible on the main screen.

Select and hold MENU in the main screen for 4 seconds to activate or deactivate the child lock.

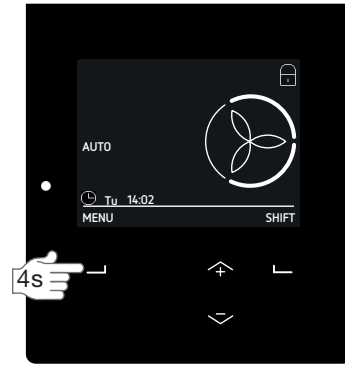

4.4 How to navigate through the unit menu

1. Open the semi-transparent visor.
2. Select MENU to gain access to the menus.
3. Use the up and down button to navigate forward and back through the menus.
4. When the selection arrow is in front of the desired option select CONFIRM.





When you are done with all your operating options:

1. Select BACK until you reach the main screen.
2. Close the semi-transparent visor.



4.5 Access the installer settings

The installer settings menu is password protected to prevent users from altering system critical settings by accident. The symbol  is displayed in the left top corner of the display when the installer password is active.

 **Do not forget to log out as an installer when you are done.**

To log in to the installer settings:

1. Select SHIFT for at least 4 seconds in the main screen.
2. Select the password number with the up and down button.
3. Select CONFIRM after each number

 **Please contact Zehnder for the password to gain access to the installer settings.**

To log out:

1. Select SHIFT in the main screen.
2. Select LOG OUT

4.6 Menu structure

Installer menu's

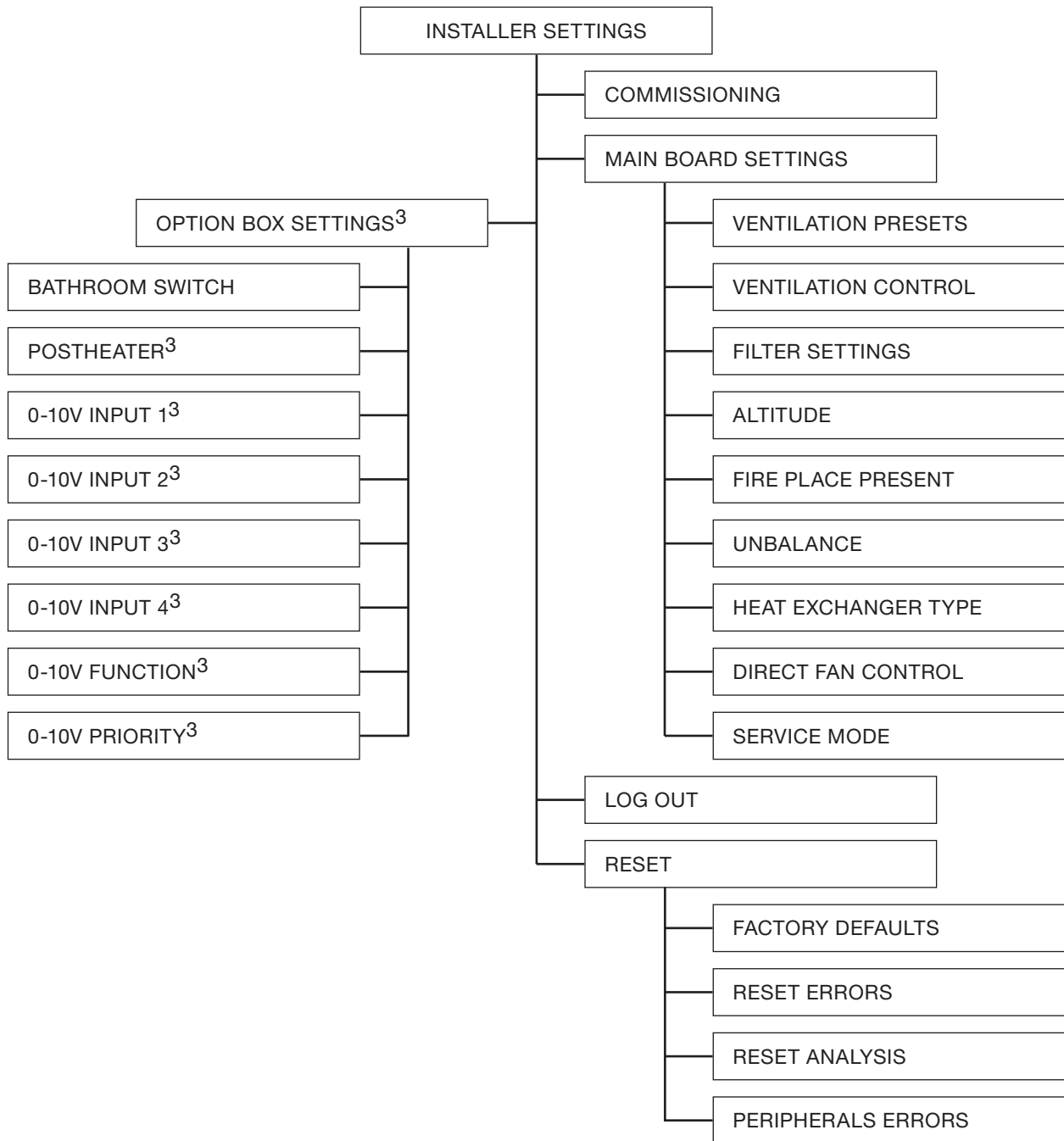

³ This menu is only visible when the accessory is connected to the unit.

User menu's

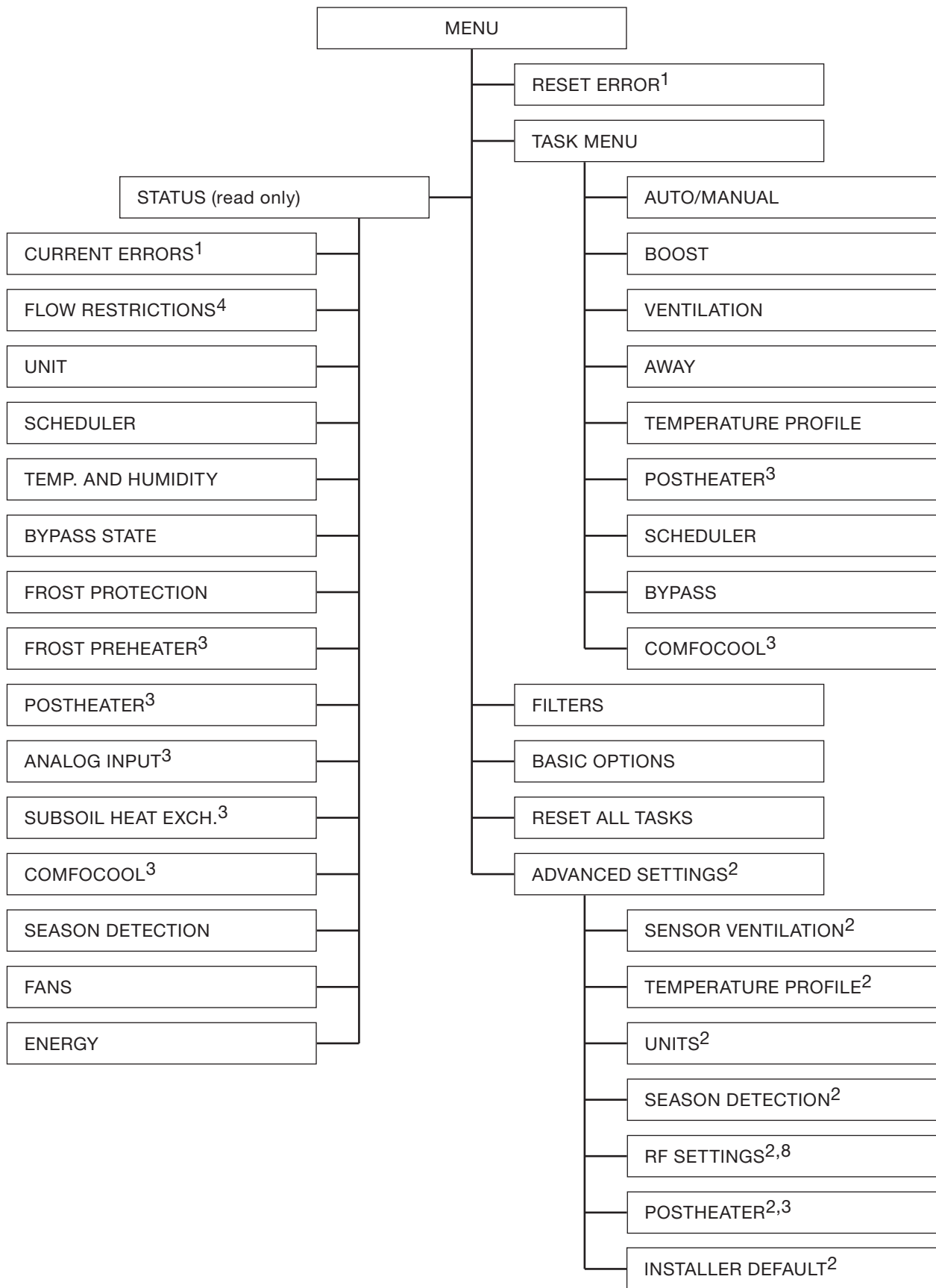

1 This menu is only visible when errors occur.

2 This menu is only visible when the advanced mode is active.

3 This menu is only visible when the accessory is connected to the unit.



4 This menu is only visible when an automated control requires a different airflow setting than requested.

8 This menu is only visible when the unit has RF functionality.

4.7 COMMISSIONING menu

When the unit has never been commissioned the commissioning wizard will automatically start up as soon as the power to the unit is switched on. The first part (basic configuration) of the commissioning wizard must be done immediately after turning on the power. These settings are necessary to protect the unit from frost and water damage. You can run the commissioning wizard again at a later date from the ORIENTATION OF THE UNIT screen by accessing this menu.

The commissioning wizard will ask you to set the following information in the first part (basic configuration)

Screen	Function
CHOOSE LANGUAGE	Select the desired display language.
SET CLOCK	Select the current date and time.
CONTINUE COMMISSIONING	The unit will ask you if you would like to commission the unit now.
PASSWORD	Select the password for accessing the installer settings. Please contact Zehnder for the password to gain access to the installer settings.
ORIENTATION OF THE UNIT	Select the required orientation of the unit: <ul style="list-style-type: none"> ■ LEFT: The supply and extract air connections are to the left side of the unit; ■ RIGHT: The supply and extract air connections are to the right side of the unit.
CONNECTION OF THE CONDENSATION DRAIN	Select the location of the installed dry siphon. The unit will then check if this is correct. The option of no condensation drain is only possible when the unit has an enthalpy exchanger installed.
FILTERS	When the orientation of the unit is changed the unit will ask you to check if the filter positions are correct. When the orientation of the unit is LEFT the location of the filters should be: <ul style="list-style-type: none"> ■  = Left side; ■  = Right side. Make sure the arrow on the filters are pointing upwards. When the supply and extract air filters are the same, there is no need to switch the filters.
PREHEATER	When a pre-heater is present the unit will check if it is in the correct location.
FLOW UNIT	Select the required unit for displaying the airflow. <ul style="list-style-type: none"> ■ m³/h; ■ l/s.
ALTITUDE	Select the altitude group above sea level in which the unit is installed. With this information the unit can determine the average environmental pressure needed for its airflow calculations.
FIREPLACE PRESENT	Select the presence of a fire place in the dwelling. If a fire place is present the unit will prevent causing under pressure in the dwelling so smoke will not be pulled in to the dwelling. <div style="border: 1px solid black; padding: 5px; margin-top: 10px;"> <p> The FIREPLACE setting is no safety feature. For safety, a delta-pressure switch switching off the ventilation in case of under pressure should still be installed.</p> </div>

The commissioning wizard will ask you to set the following information in the second part:

Screen	Function
MAXIMUM FLOW	The unit instructed you to prepare the system for a maximum flow test. When opening all valves also open all grilles and close all windows and doors.
ARE ALL VALVES COMPLETELY OPEN?	The unit will ask you if the system is ready for the maximum airflow test before starting the test.
MAXIMUM FLOW	After the maximum flow test is completed the unit will tell you the expected maximum flow of the system.
INSTRUCTION	The unit will ask you not to change the preparations you made for the maximum flow test till instructed.
MEDIUM AIR FLOW	Select the desired airflow for PRESET 2.
MAXIMUM AIR FLOW	Select the desired airflow for PRESET 3.
LOW AIR FLOW	Select the desired airflow for PRESET 1.
AWAY AIR FLOW	Select the desired airflow for PRESET A.
COMMISSIONING AIR FLOW	Select the desired airflow in which you would like to commission the valves and/or grilles.
FINE TUNE ALL EXTRACT AND SUPPLY VALVES	Use a flow meter to set the valves and/or grilles into the correct position. Start with the valve or grille farthest from the unit and work back along the air duct to the unit.
ARE ALL VALVES FINE TUNED	The unit will ask you if all valves and/or grilles are commissioned before checking the maximum air flow.
CHECK AIRFLOW	The unit will warn you if the selected maximum air flow is unable to be achieved. It is recommended you adjust the system to reduce the pressure drop and enable the required airflow rate to be achieved. You can also ignore this information.
END OF THE INSTALLATION WIZARD	The unit will tell you that the commissioning wizard is completed and will store all settings after confirmation.

It would be beneficial to the end user if the advanced user menu options were also setup during the commissioning procedure, for example the SENSOR VENTILATION settings. Information on how to set these can be found within the user manual.

4.8 MAIN BOARD SETTINGS menu

4.8.1 VENTILATION PRESETS menu

If you have gone through the commissioning wizard you will have already set the desired ventilation presets there. In this menu you can alter them without having to go through the whole commissioning wizard again.

In this menu you cannot set a preset higher than the next preset. It is best to set the maximum preset first and work back to the lower presets.

Default settings before commissioning			
ComfoAir Q	350	450	600
PRESET A	20 l/s	20 l/s	20 l/s
PRESET 1	45 l/s	60 l/s	75 l/s
PRESET 2	65 l/s	80 l/s	100 l/s
PRESET 3	80 l/s	100 l/s	125 l/s

4.8.2 VENTILATION CONTROLS menu

In this menu you can set how the unit must respond to external influences like changes in air resistance in the system.

FLOW CONTROL

The factory default for the unit is set to FLOW CONTROL. The unit will regulate the airflow around the set airflow. External influences on the airflow will be corrected only when necessary, while small and short variations in airflow are allowed. This ensures a more steady behaviour of the fan speed.

CONSTANT FLOW

The unit will regulate the airflow to the exact set airflow. External influences on the airflow will be corrected immediately. The fan speed will constantly be corrected.

4.8.3 FILTER SETTINGS menu

The factory default for the filter warning is 21 days before the unit expects its filters need to be replaced. This allows the user sufficient time to purchase new filters before the filters are completely contaminated. The amount of air passing through the filters determines how quickly the filters should be replaced. The filters must be replaced at least every 180 days. If the unit is running at a high airflow rate, then the unit will automatically shorten this time. In addition, it is also possible to display this notification earlier by increasing the number of filter order days in the FILTER WARNING menu.

You can choose to replace the filters of all the units in your service contract on the same day. This will probably mean that you are replacing filters for units which do not have a filter warning yet. In this case you can run the filter wizard by starting user menu CHANGE FILTERS in the FILTERS menu. After finishing the filter wizard, the filter counter will be reset automatically.

 **Do not change the filters when the unit is powered without using the filter wizard. For safety reasons the unit will stop ventilating during the filter replacement instructions.**

4.8.4 ALTITUDE menu

If you have gone through the commissioning wizard you will have already set the altitude of the unit there. In this menu you can alter it without having to go through the whole commissioning wizard again.

Default settings before commissioning	
Setting	Meaning
0 - 500 m	the unit is maximally installed 500m above sea level

4.8.5 FIRE PLACE PRESENT menu

If you have gone through the commissioning wizard you will have already set the presence of a fire place in the dwelling there. In this menu you can alter it without having to go through the whole commissioning wizard again.

Default settings before commissioning	
Setting	Meaning
NO	the unit will allow the function EXTRACT ONLY. A positive and a negative unbalance can be set in the UNBALANCE menu.

4.8.6 UNBALANCE menu

If you leave the UNBALANCE menu on 0% the unit will make sure the amount of incoming air is the same as the amount of outgoing air. The unit will take the difference in channel resistance into account. Leave the value in this menu on 0% to make sure both airflows remain in balance.

In some cases you may want to create an unbalance between the incoming and outgoing air.

To create an over pressure in the dwelling set the UNBALANCE menu to a positive setting. The unit will decrease the airflow of the supply air by the set percentage. This option is not possible when the menu FIRE PLACE PRESENT is set to YES.

To create an under pressure in the dwelling set the UNBALANCE menu to a negative setting. The unit will decrease the airflow of the extract air by the set percentage.

4.8.7 HEAT EXCHANGER TYPE menu

If you replace the heat exchanger with a different type than installed in the factory you need to change the setting in this menu.

Menu item	Function
HRV	Standard heat exchanger installed.
ERV	Enthalpy heat exchanger installed.

4.8.8 DIRECT FAN CONTROL menu

Do not activate this menu.

The unit is equipped with ventilation control and unbalance which will regulated the airflow between the two fans. DIRECT FAN CONTROL will turn off these controls.

4.8.9 SERVICE MODE menu

The unit is equipped with a SERVICE MODE to enable the maintenance of the device possible. By activating this mode the basic functions of the device will be turned off and the bypass valves removed from the heat exchanger. You must still disconnect the power to the unit manually to prevent touching live electrically conductive parts.

When the power on the device is switched on again the SERVICE MODE will automatically turn off.

The unit will automatically log out of the password protected INSTALLER SETTINGS menu.

4.9 OPTION BOX SETTINGS³ menu

If the unit is equipped with an Option Box the menu OPTION BOX SETTINGS will appear. You can find more information about the option box and this menu in the option box manual.

4.10 LOG OUT menu

You can log out of the password protected INSTALLER SETTINGS menu by navigating to this menu.

4.11 Reset options

The unit is equipped with several reset options. The following reset options are accessible to the user:

Menu item	Function
RESET ERROR	Reset all active error messages. When the error causing the message is not resolved the error message will come back again over time.
RESET EXCL SCHEDULE (You can find this menu under RESET ALL TASKS)	When this menu is activated all settings in the TASK MENU excluding the set scheduler(s) will be returned to the (default) factory settings.
RESET INCL SCHEDULE (You can find this menu under RESET ALL TASKS)	When this menu is activated all settings in the TASK MENU including the set scheduler(s) will be returned to the (default) factory settings.
INSTALLER DEFAULT ² (You can find this menu under ADVANCED SETTINGS)	When the option RESET is activated all settings will be returned to the (default) installer settings.

The following reset options can be found in the INSTALLER SETTINGS > RESET menu:

Menu item	Function
FACTORY DEFAULTS	Restore the unit default settings to the first power-up settings. You must commission the unit again.
RESET ERRORS	Reset all active error messages excluding peripherals errors. When the error causing the message is not solved the error message will come back again over time.
RESET ANALYSIS	Reset the data from the STATUS menu.
PERIPHERALS ERRORS (Ancillarie(s) which has been present, but is/are no longer detected)	Disconnect the ancillary/ancillaries causing an error. Do not use this menu when the function of the ancillary/ancillaries causing the error are required. Following this reset the unit will assume the ancillary/ancillaries has never been present, until it is detected once again.

4.12 Software update

A registered installer can update the unit firmware to the latest function, using the ComfoConnect LAN C. You can request a login to become a registered installer by contacting Zehnder. Country specific settings and variant specific settings will remain unchanged. The commissioning wizard is not required to be performed after a firmware update. In the ComfoConnect Cloud menu, either connected locally or via Remote Support, the latest firmware version can be downloaded.

³ This menu is only visible when the accessory is connected to the unit.

5 Maintenance procedures

 **Follow all maintenance procedures given in this chapter and in the user manual. If the maintenance is not performed periodically the performance of the ventilation system will ultimately be compromised.**

In this chapter you can find a separate subchapter for each maintenance action which it is recommended the user should not perform. In the user manual you will find all maintenance actions which the user may perform.

You can find the maintenance procedures of the ancillaries connected to the unit in their relevant manuals. You can get a copy of a Zehnder manual from Zehnder.







If it is necessary to replace a part, you can order a service part from Zehnder. In the chapter about the service parts you can see which special service sets are available.

 **Always disconnect the power supply to the unit and optional connected ComfoSplitter before you start working on the ventilation system. The unit can cause personal injury when it is open while running. Make sure the unit cannot switch back on by accident.**

 **Always take ESD-inhibiting measures when dealing with electronics, such as wearing an antistatic wristband. The electronics can get damaged by static charges.**

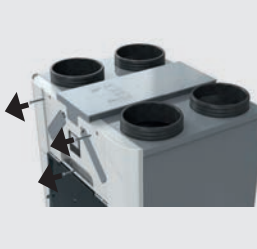

Zehnder recommend that you employ a specialised cleaning firm to clean the whole ventilation system.

5.1 Procedure for opening the unit

	<p>1</p> 	<p>2</p> 
<p> Do not disconnect the power to the unit yet. The current setting of the modulating bypass valve may block the removal of the heat exchanger.</p>	<p>Open the semi-transparent visor.</p>	<p>Change the unit to SERVICE MODE. (INSTALLER SETTINGS > MAIN BOARD SETTINGS > SERVICE MODE > SERVICE MODE).</p>
<p>3</p> 	<p>4</p> 	<p>5</p> 
<p>Disconnect the power to the unit when the display tells you to.</p>	<p>Remove the 3 front cover screws.</p>	<p>Remove the front cover.</p>



5.2 Maintenance of the casing

Inspect the unit casing at least once every 4 years.

<p>1</p> 	<p>2</p> 	<p>3</p> 
<p>Remove the front cover as instructed in the chapter "Procedure for opening the unit":</p> <ul style="list-style-type: none"> ■ Open the semi-transparent visor; ■ Change the unit to SERVICE MODE; ■ Disconnect the power to the unit; ■ Remove the 3 front cover screws; ■ Remove the front cover. 	<p>Perform the next checks:</p> <ul style="list-style-type: none"> ■ Check the seals for damage; ■ Check the inside and outside for dirt and damage; ■ Check the duct connections for dirt and damage. 	<p>Treat any signs of corrosion and other damage directly and appropriately.</p> <p>! Do not treat the front foam and the EPP parts (black hard parts with structure) with soap. Soap will destroy the air- and water thightness of the material.</p>

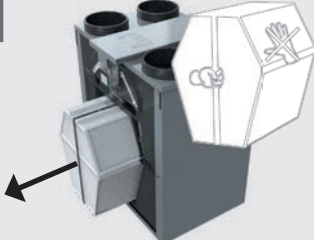

5.3 Maintenance of the heat exchanger

Inspect the heat exchanger at least once every 4 years.





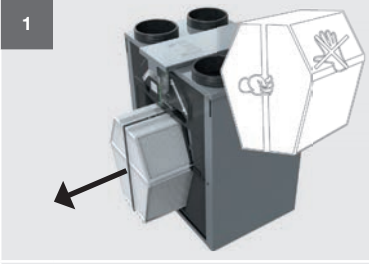
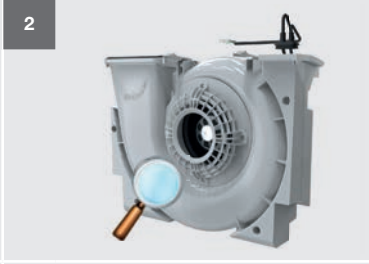

<p>1</p> 	<p>2</p> 	<p>3</p> 
<p>Remove the front cover as instructed in the chapter "Procedure for opening the unit":</p> <ul style="list-style-type: none"> ■ Open the semi-transparent visor; ■ Change the unit to SERVICE MODE; ■ Disconnect the power to the unit; ■ Remove the 3 front cover screws; ■ Remove the front cover. 	<p>Remove the heat exchanger:</p> <ul style="list-style-type: none"> ■ Pull the strap of the heat exchanger. <p>! Do not cut the strap. The strap is necessary to pull out the heat exchanger from the unit.</p> <p>You can only remove the heat exchanger without damaging the unit when the unit is in SERVICE MODE.</p> <p>! During assembly: Place the bottom of the heat exchanger in the guide rails of the unit. Make sure the red bottom plate is on the front side of the heat exchanger.</p>	<p>Inspect and, if necessary, clean the heat exchanger.</p> <ul style="list-style-type: none"> ■ Use water to remove dirt and dust: <ol style="list-style-type: none"> a. Submerge the heat exchanger several times in hot water (max. 40°C). b. Rinse the heat exchanger with clean hot tap water (max. 40°C). c. Clasp the heat exchanger between both hands (on the solid side surfaces) and shake the excess water from the heat exchanger. <p>! Do not use aggressive cleaning agents or solvents. These may damage the air seal of the heat exchanger.</p>

5.4 Maintenance of the fans

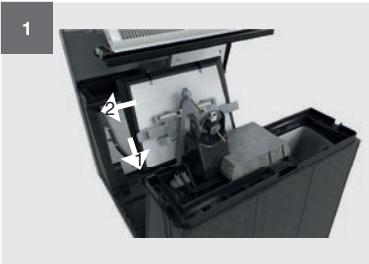
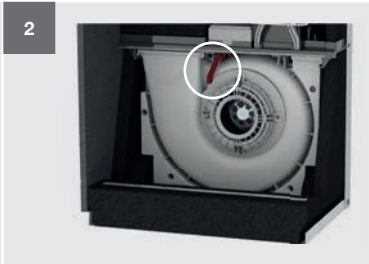
Inspect the fans at least once every 4 years.



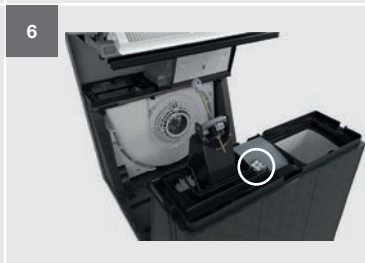

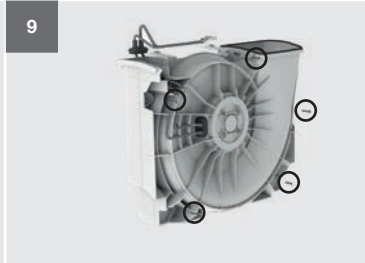
		
<p>Remove the heat exchanger as instructed in the maintenance instruction of the heat exchanger:</p> <ul style="list-style-type: none"> ■ Open the semi-transparent visor; ■ Change the unit to SERVICE MODE; ■ Disconnect the power to the unit; ■ Remove the 3 front cover screws; ■ Remove the front cover; ■ Pull the strap of the heat exchanger. 	<p>Perform the next checks:</p> <ul style="list-style-type: none"> ■ Check the flow grid for dirt and damage; ■ Check the casing for dirt and damage; ■ Check the fan impellers for dirt and damage. 	<p>If necessary, clean the fans and flow grid.</p> <ul style="list-style-type: none"> ■ Use a soft brush to clean the fan impellers; ■ Use a vacuum cleaner to remove dust. <p> Take care to ensure the fan impellers do not get damaged.</p>

For better access to the fan follow the next steps:

		
<p>Remove the modulating bypass valve as instructed in the chapter "How to remove the modulating bypass valve":</p> <ul style="list-style-type: none"> ■ Open the semi-transparent visor; ■ Change the unit to SERVICE MODE; ■ Disconnect the power to the unit; ■ Remove the 3 front cover screws; ■ Remove the front cover; ■ Pull the strap of the heat exchanger. ■ Pull the clamp, located at the back of the valve, away from the valve. ■ While holding the clamp away from the valve pull the valve towards you. 	<p>Remove the two pressure hoses from the fan.</p>	<p>Press the two holding clamps downwards and pull the scroll housing forwards.</p>
		
<p>Release the connection joint of the modulating bypass valve.</p>	<p>Remove the insulation cover behind the modulating bypass valve.</p>	<p>Remove the fan connectors from the sensor cover and open them.</p>
		
<p>Remove the grommet including cabling.</p>	<p>Lift the scroll housing out of the unit.</p>	<p>Remove the 5 screws on the edge of the scroll housing to open the scroll housing.</p>

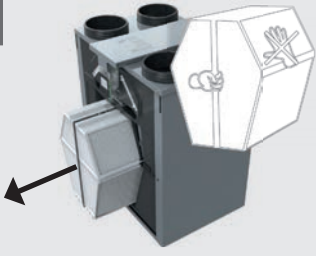





5.5 Maintenance of the modulating bypass valves

Inspect the modulating bypass valves at least once every 4 years.

		
<p>Remove the heat exchanger as instructed in the maintenance instruction of the heat exchanger:</p> <ul style="list-style-type: none"> ■ Open the semi-transparent visor; ■ Change the unit to SERVICE MODE; ■ Disconnect the power to the unit; ■ Remove the 3 front cover screws; ■ Remove the front cover; ■ Pull the strap of the heat exchanger. 	<p>Inspect the modulating bypass valves for dirt and damage.</p>	<p>Treat any signs of dirt or damage directly and appropriately.</p> <p> Remove the modulating bypass valve for easy cleaning. You can find the instructions for removing the modulating bypass valve in the chapter "How to remove the modulating bypass valve".</p>

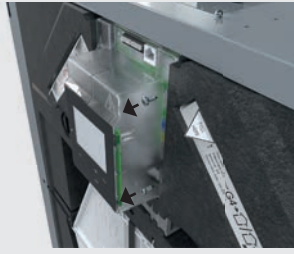

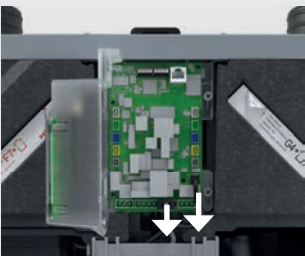
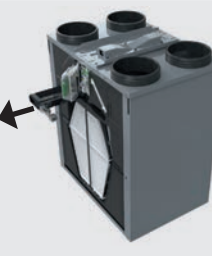
5.6 Maintenance of the pre-heater

Inspect the pre-heater at least once every 4 years.

		
<p>Remove the front cover as instructed in the chapter "Procedure for opening the unit":</p> <ul style="list-style-type: none"> ■ Open the semi-transparent visor; ■ Change the unit to SERVICE MODE; ■ Disconnect the power to the unit; ■ Remove the 3 front cover screws; ■ Remove the front cover. 	<p>Pull the cable tray cover forwards.</p>	<p>Remove any connected wire from the ComfoConnect connectors.</p> <p> Zehnder recommends noting down the colour code of the wires before removal.</p> <p>Remove the 2 display cover screws. Open the display cover.</p>
		
<p>Remove the pre-heater communication and power cable from the main board.</p>	<p>Remove the pre-heater, including its cable and grommet, from the unit.</p>	<p>Inspect the pre-heater for dirt and damage.</p> <p>Treat any signs of dirt or damage directly and appropriately.</p> <p>Turn the pre-heater upside down and:</p> <ul style="list-style-type: none"> ■ Use a soft brush to clean the fins; ■ Or use a vacuum cleaner to remove dirt and dust. <p> Do not wet-clean the pre-heater.</p>



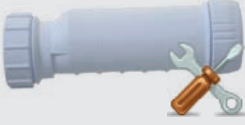

5.7 Maintenance of the condensation drain

Inspect the condensation drain at least once every 4 years.



<p>1 Example siphon</p> 	<p>2 Example siphon</p> 	<p>3</p> 
<p>Disconnect the condensation drain.</p>	<p>Perform the next checks on the condensation drain siphon:</p> <ul style="list-style-type: none"> ■ Check whether the drain is still open by adding water to the siphon; ■ Visually inspect the condensation drain for contamination; ■ Check if the seal of the condensation drain is air tight. Air must not pass through or by the siphon. 	<p>Resolve any observed problems.</p>

5.8 Maintenance of the air ducts



Inspect the air ducts at least once every 4 years.

<p>1 Example valve Example grille</p> 	<p>2 Example air duct</p> 	<p>3</p> 
<p>Remove the valves and/or grilles.</p> <p> Zehnder recommends noting down the setting and location before removal.</p>	<p>Perform the next checks on the air ducts:</p> <ul style="list-style-type: none"> ■ Pollution (dirt and grease); ■ Air leakage (loose joints); ■ Resistance (bends, dents and blocked valves); ■ Valves and/or grilles. ■ Valves. ■ Grilles. 	<p>Resolve any observed problems.</p>

It is recommended the exhaust duct is cleaned every 4 years and the supply duct every 8 years.

<p>1 Example brush</p> 	<p>2 Example vacuum cleaner</p> 	
<p>Loosen the dirt.</p>	<p>Remove the dirt with a vacuum cleaner or filter box.</p> <p> Do not use the unit to remove the dirt from the air ducts. The dirt can damage the unit or furniture in the dwelling.</p>	

5.9 Procedure for ending the maintenance

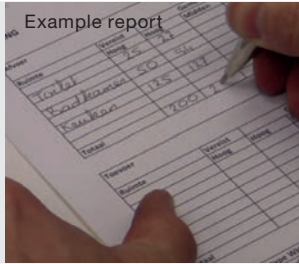
		
<p>Install all parts back in reverse order.</p>	<p>Connect the power to the unit.</p>	<p>Fill in the maintenance log (if present). You can find an example of a maintenance log in the user manual.</p>
<p>During installation:</p> <ul style="list-style-type: none"> ■ Set the unit to SERVICE MODE to ensure the modulating bypass valves are not blocking the installation of the heat exchanger; ■ Tighten all screws manually (max. 1.5 Nm); ■ Place all cables in their guiding channels; ■ Place the bottom edge of the front behind the raised edge of the bottom plate. This will guarantee an air-tight seal after the screws are tightened. 		

6. Malfunction procedures

⚠ Always disconnect the power supply to the unit and optional connected ComfoSplitter before you start working on the unit. The unit can cause personal injury when it is open while running. Make sure the unit cannot switch back on by accident.

Do not disconnect the power to the unit the instructions inform you to.

⚠ Often power is needed on the unit during troubleshooting while the unit is open. At all times be aware of the danger of electrical shocks and rotating parts. Therefore always take all the possible precautions to protect yourself and others during troubleshooting.

⚠ Always take ESD-inhibiting measures when dealing with electronics, such as wearing an antistatic wristband. The electronics can get damaged by static charges.

The device will always try to ensure a comfortable and healthy environment by ventilating. In case of a malfunction this is not always possible. The device will adjust its controls during a malfunction to prevent any further damage to the device. In order to ensure a healthy and comfortable living environment for the user, errors must be resolved as quickly as possible.

In the chapter “What to do in the event of a malfunction alert (troubleshooting)” you can find how to resolve all malfunction codes.

6.1 How to reset errors

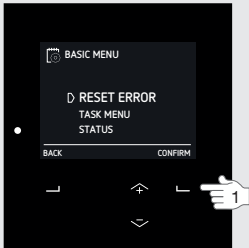
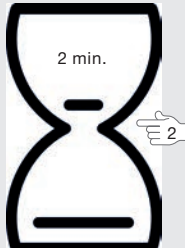
		
<p>Open the semi-transparent visor.</p>	<p>Navigate to RESET ERROR.</p>	<p>Wait for 2 minutes to see if the error returns.</p>

6.2 How to remove ancillaries



1 Open the semi-transparent visor.



2 Navigate to PERIPHERALS ERRORS.

6.3 Malfunction alerts on the display of the unit¹





Code display of the unit	Code ComfoSense C	Meaning
CCOOL_COMPRESSOR ERROR	1091	The ComfoCool Q600 Compressor has a malfunction.
CCOOL_CONNECT ERROR	1075	There is no communication between the ComfoCool Q600 and the unit.
CCOOL_TEMP ERROR	1092, 1093, 1094	One or more ComfoCool Q600 temperature sensors have a malfunction.
CHANGE FILTERS NOW	1077	The internal filters need to be replaced.
COMFOCOOL_HEAT ERROR	1090	The ComfoCool Q600 condenser is overheating.
CONFIGURATION ERROR	1099	The configuration is not up to date.
DANGER! OVERHEATING!	1021	Two or more sensors are detecting an incorrect temperature.
EXPECT FILTER CHANGE SOON	1079	The internal filters almost need to be replaced.
		Order the new filters now
EXT_PRESSURE_EHA ERROR	1053	The system resistance in the extract-exhaust airflow is too high.
EXT_PRESSURE_SUP ERROR	1054	The system resistance in the outdoor-supply airflow is too high.
EXTERNAL FILTER ALARM	1078	The external filter is dirty.
FAN_EHA ERROR	1051, 1055	The exhaust air fan has a malfunction.
FAN_SUP ERROR	1052, 1056	The supply air fan has a malfunction.
GENERAL ERROR xxxxx	xxxx	An error without description occurred. Take note of the number.
GROUND_HEAT_CONNECT ERROR	1076	There is no communication between the ComfoFond-L Q temperature sensor and the unit.
INIT ERROR	1033	The unit has not been commissioned.
OPTION_BOX CONNECT ERROR	1067	There is no communication between the option box and the unit.
POSTHEAT_CONNECT ERROR	1069	There is no communication between the post-heater temperature sensor and the unit.
PREHEAT ERROR	1037, 1038, 1059, 1081	The preheater has a malfunction.
PREHEAT_LOCATION ERROR	1035	The preheater is not in the correct location.
PREHEAT_PRES ERROR	1068	There is no communication between the preheater and the unit.
SENSOR_EHA ERROR	1025, 1041, 1049	The exhaust air sensor has a malfunction.
SENSOR_ETA ERROR	1023, 1039	The extract air sensor has a malfunction.
SENSOR_ODA ERROR	1027, 1029, 1043, 1045	The outdoor air sensor has a malfunction.
SENSOR_SUP ERROR	1031, 1047, 1050	The supply air sensor has a malfunction.
SERVICE MODE	1080	The basic functions of the unit are stopped to enable the required maintenance to be carried out.
TEMP_HRU ERROR	1022	The outdoor air temperature is too high or low.
TEMP_SENSOR_EHA ERROR	1026	The exhaust air temperature sensor is detecting an incorrect temperature.
TEMP_SENSOR_ETA ERROR	1024	The extract air temperature sensor is detecting an incorrect temperature.
TEMP_SENSOR_ODA ERROR	1028, 1030	The outdoor air temperature sensor is detecting an incorrect temperature.
TEMP_SENSOR_SUP ERROR	1032	The supply air temperature sensor is detecting an incorrect temperature.
TEMP_SUP_MIN ERROR	1061	The supply air temperature is too low.
UNBALANCE ERROR	1062	The airflow balance (or unbalance setting) can not be guaranteed.

¹ Applies to software version R1.6.0

6.4 How to gain access to the ComfoNet connectors on the unit

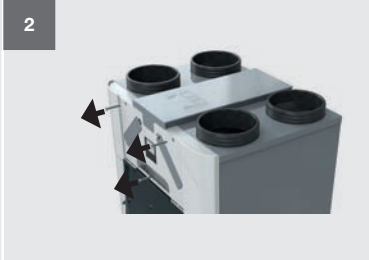
		
<p>Disconnect the power to the unit. Open the semi-transparent visor.</p>	<p>Pull the cable tray cover forwards.</p>	<p>1 = ComfoNet plug-in connection 2 = ComfoNet plug-in connection 3 = ComfoNet RJ45 connection</p>

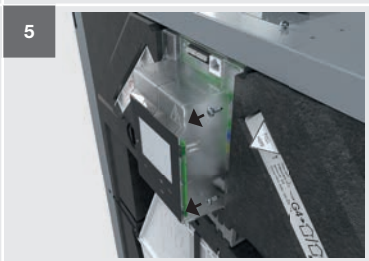
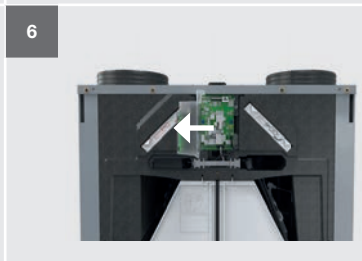



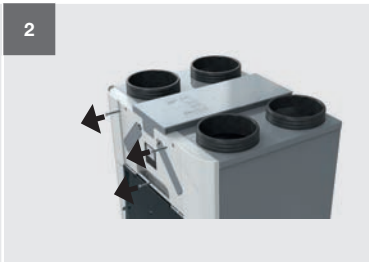
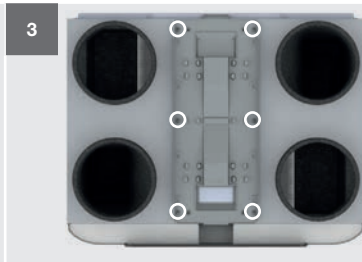

6.5 How to gain access to the main board

		
<p>Disconnect the power to the unit. Open the semi-transparent visor.</p>	<p>Remove the 3 front cover screws.</p>	<p>Remove the front cover.</p>
		
<p>Pull the cable tray cover forwards.</p>	<p>Remove any connected wire from the ComfoConnect connectors.</p> <p> Zehnder recommends noting down the used colour code of the wires before removal.</p> <p>Remove the 2 display cover screws.</p>	<p>Open the display cover.</p>

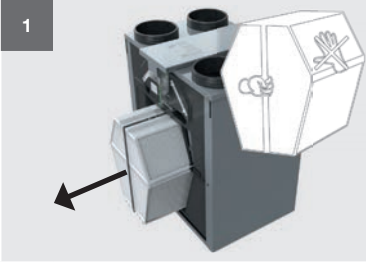
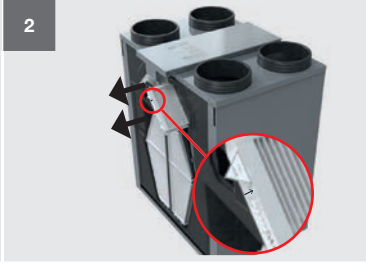





6.6 How to gain access to the main power fuse of the unit

		
<p>Disconnect the power to the unit. Open the semi-transparent visor.</p>	<p>Pull the cable tray cover forwards.</p>	<p>Remove the 6 screws of the cable tray. Carefully lift up the cable tray.</p>

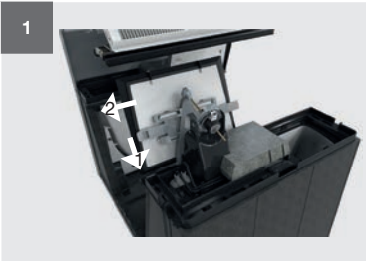
6.7 How to gain access to the top-section sensor

		
<p>Remove the heat exchanger as instructed in the maintenance instruction of the heat exchanger:</p> <ul style="list-style-type: none"> ■ Open the semi-transparent visor; ■ Change the unit to SERVICE MODE; ■ Disconnect the power to the unit; ■ Remove the 3 front cover screws; ■ Remove the front cover; ■ Pull the strap of the heat exchanger. 	<p>Remove the filters (and when present the pre-heater).</p> <p>During installation:</p> <ul style="list-style-type: none"> ■ Make sure the arrow on the filters is pointing upwards. ■ When the orientation of the unit is RIGHT the location of the filters should be: <ul style="list-style-type: none">  = Left side;  = Right side. ■ When the orientation of the unit is LEFT the location of the filters should be: <ul style="list-style-type: none">  = Left side;  = Right side. 	<p>Pull the sensor, from the inside of the unit, down. Then remove the sensor connector.</p> 

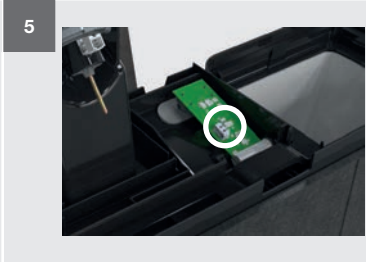

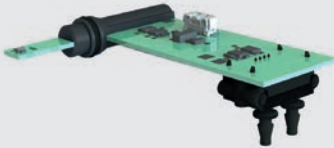

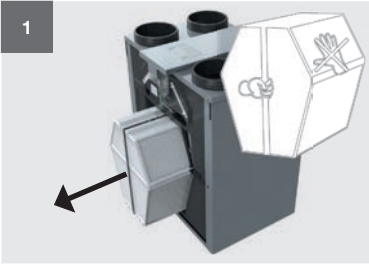
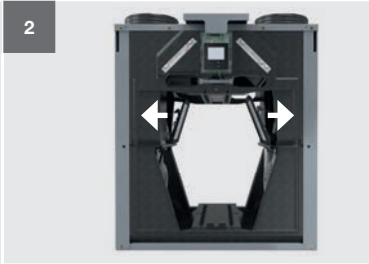
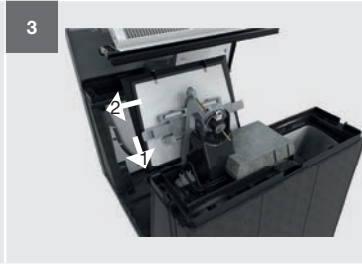

6.8 How to gain access to the mid-section sensor

		
<p>Remove the modulating bypass valve as instructed in the chapter "How to remove the modulating bypass valve":</p> <ul style="list-style-type: none"> ■ Open the semi-transparent visor; ■ Change the unit to SERVICE MODE; ■ Disconnect the power to the unit; ■ Remove the 3 front cover screws; ■ Remove the front cover; ■ Pull the strap of the heat exchanger. ■ Pull the clamp, located at the back of the valve, away from the valve. ■ While holding the clamp away from the valve pull the valve towards you. 	<p>Release the connection joint of the modulating bypass valve.</p>	<p>Remove the insulation cover behind the modulating bypass valve.</p>
		
<p>Remove the fan connectors from the sensor cover. Remove the sensor cover by opening the snap connection.</p> <p>! During installation: Place the sensor cover underneath the guide rails and place the fan connectors back. This will guarantee a good fit of the insulation cover.</p>	<p>Remove the connector for the sensor</p> 	<p>Pull the sensor up out of its rubber pressure sensor holder. Then pull the sensor sideways and out of the sensor compartment.</p>

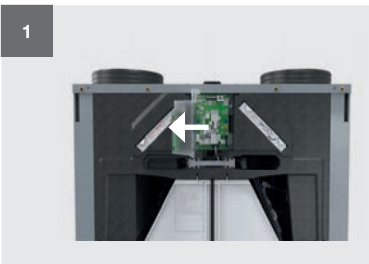
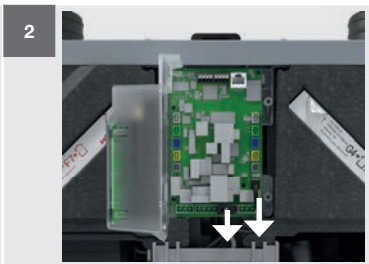
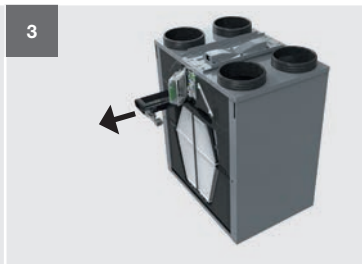
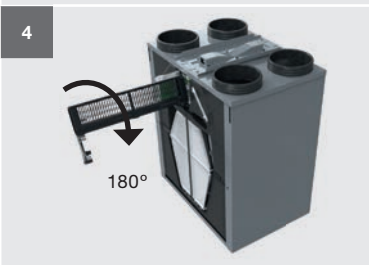
6.9 How to remove the modulating bypass valve

		
<p>Remove the heat exchanger as instructed in the maintenance instruction of the heat exchanger:</p> <ul style="list-style-type: none"> ■ Open the semi-transparent visor; ■ Change the unit to SERVICE MODE; ■ Disconnect the power to the unit; ■ Remove the 3 front cover screws; ■ Remove the front cover; ■ Pull the strap of the heat exchanger. 	<p>Pull the clamp, located at the back of the valve, away from the valve.</p>	<p>While holding the clamp away from the valve pull the valve towards you.</p>

6.10 How to change the location of the pre-heater

		
<p>Access the main board as instructed in the chapter "How to gain access to the main board"</p> <ul style="list-style-type: none"> ■ Disconnect the power to the unit; ■ Open the semi-transparent visor; ■ Remove the 3 front cover screws; ■ Remove the front cover; ■ Pull the cable tray cover forwards; ■ Remove any connected wire from the ComfoConnect connectors; ■ Remove the 2 display cover screws; ■ Open the display cover. 	<p>Pull the pre-heater communication and power cable from the main board.</p>	<p>Pull the pre-heater, including its cable and grommet, from the unit.</p>
		
<p>Rotate the pre-heater 180°.</p>	<p>Slide the pre-heater, including its cable and grommet, back on the other side of the unit:</p> <ul style="list-style-type: none"> ■ When the orientation of the unit is RIGHT the location of the pre-heater should be on the left side; ■ When the orientation of the unit is LEFT the location of the pre-heater should be on the right side. 	<p>Check if the filters are in the correct position:</p> <ul style="list-style-type: none"> ■ When the orientation of the unit is RIGHT the location of the filters should be: <ul style="list-style-type: none">  = Left side;  = Right side. ■ When the orientation of the unit is LEFT the location of the filters should be: <ul style="list-style-type: none">  = Left side;  = Right side.

6.11 What to do in the event of a malfunction alert (troubleshooting)

Malfunction code CCOOL_COMPRESSOR ERROR		The ComfoCool Q600 compressor has a malfunction.	
	Question	Answer	Action
1	Is the ComfoCool Q600 compressor off?	Yes	1. Reset the errors as instructed in the chapter "How to reset errors". 2. Go to the next question.
		No	Go to the next question.
2	Did the error come back?	Yes	1. Get the ComfoCool Q600 skid service set. 2. Replace the ComfoCool Q600 cooling skid as instructed in its supplied manual. 3. Follow the procedure for ending the maintenance.
		No	Follow the procedure for ending the maintenance.

Malfunction code CCOOL_CONNECT ERROR / OPTION_BOX CONNECT ERROR.		There is no communication between the ComfoCool Q600 / option box and the unit.	
	Question	Answer	Action
1	-	-	1. Access the ComfoNet connectors as instructed in the chapter "How to gain access to the ComfoNet connectors on the unit". 2. Go to the next question.
2	Are the connections at the ComfoNet connector correct? ⁴	Yes	1. Access the ComfoCool Q600 / option box connections. 2. Go to the next question.
		No	1. Reconnect the ComfoCool Q600 / option box to the unit. 2. Follow the procedure for ending the maintenance.
3	Are the connections at the ComfoCool Q600 / option box correct? ⁴	Yes	Go to the next question.
		No	1. Reconnect the ComfoCool Q600 / option box to the unit. 2. Follow the procedure for ending the maintenance.
4	Is something wrong with the ComfoCool Q600 / option box cable?	Yes	1. Replace the cable. 2. Follow the procedure for ending the maintenance.
		No	1. Get a new ComfoCool Q600 / option box. 2. Replace the ComfoCool Q600 / option box. 3. Follow the procedure for ending the maintenance. 4. Go to the next question.
5	Is the error still present?	Yes	1. Get the main board service set. 2. Replace the main board as instructed in its supplied manual. 3. Follow the procedure for ending the maintenance.

Malfunction code CCOOL_TEMP ERROR		One or more ComfoCool Q600 temperature sensors have a malfunction.	
	Question	Answer	Action
1	Are the connections of the ComfoCool Q600 condenser temperature sensor correct?	Yes	Go to the next question.
		No	1. Reconnect the temperature sensor. 2. Follow the procedure for ending the maintenance.
2	Are the connections of the ComfoCool Q600 supply temperature sensor correct?	Yes	1. Measure the resistance of the ComfoCool Q600 supply temperature sensor. 2. Go to the next question.
		No	1. Reconnect the temperature sensor. 2. Follow the procedure for ending the maintenance.
3	Is the resistance of the supply temperature sensor correct? (approx. 10 kΩ at 25°C).	Yes	1. Get the ComfoCool Q600 NTC condenser sensor service set. 2. Replace the sensor as instructed in its supplied manual. 3. Follow the procedure for ending the maintenance.
		No	1. Get the ComfoCool Q600 NTC supply sensor service set. 2. Replace the sensor as instructed in its supplied manual. 3. Follow the procedure for ending the maintenance.

⁴ You can find the correct connection in the "Technical specification" chapter.

Malfunction code CHANGE FILTERS NOW	The internal filters need to be replaced.
--	--

Action

Replace the filters right away as instructed in the user manual.

Malfunction code COMFOCOOL_HEAT ERROR	The ComfoCool Q600 condenser is overheating.
--	---

	Question	Answer	Action
1	Is the CONDENSER TEMP below 58°C?	Yes	1. Reset the errors as instructed in the chapter "How to reset errors". 2. Check after a few minutes whether the system has reactivated.
		No	1. Set the unit to PRESET 3 to speed up the temperature change in the ComfoCool Q600. 2. Set the unit to VENTILATION CONTROL mode CONSTANT FLOW to get a fast increase on the airflow in the ComfoCool Q600. 3. Wait until the temperature of the ComfoCool Q600 condenser has fallen adequately. 4. Reset the errors as instructed in the chapter "How to reset errors". 5. Check after a few minutes whether the system has reactivated.

Malfunction code CONFIGURATION ERROR	The configuration is not up to date.
---	---

Action

1. Update the unit software or contact a registered installer to update the unit software.
For more information see chapter "Software update".
2. Fill in the maintenance log (if present).

Malfunction code DANGER! OVERHEATING!	Two or more sensors are detecting an incorrect temperature.
--	--

Question	Answer	Action
Was or is the temperature < -40°C or > 70°C?	Yes	1. Solve the problem for the extreme temperature. 2. Reset the errors as instructed in the chapter "How to reset errors". 3. Perform all maintenance actions to check if there is permanent damage to the system. 4. Follow the procedure for ending the maintenance.
	No	Solve the sensor errors as instructed in their relevant troubleshooting table.

Malfunction code EXPECT FILTER CHANGE SOON	The internal filters almost need to be replaced.
---	---

Action

1. Order new filters.
2. Replace the filters as instructed in the user manual.

Malfunction code EXT_PRESSURE_EHA ERROR / EXT_PRESSURE_SUP ERROR.	The system resistance in the extract-exhaust / outdoor-supply airflow is too high. ■ When orientation is RIGHT: pressure sensor EHA is on the left side; ■ When orientation is LEFT: pressure sensor EHA is on the right side.
--	---

	Question	Answer	Action
1	Is the airflow blocked? (Check: filters, fire valves, inlet/outlet valves, inlet/outlet grilles, air ducts, condensation in the heat exchanger)	Yes	1. Solve the blockage.  You can remove condensate from the heat exchanger by ventilating on setting PRESET 3. 2. Follow the procedure for ending the maintenance. 3. Reset the errors as instructed in the chapter "How to reset errors".
		No	1. Access the main board as instructed in the chapter "How to gain access to the main board". 2. Go to the next question.
2	Are the connections at the main board correct? ⁴	Yes	1. Check the connector on the sensor side. In chapter "How to gain access to the mid-section sensor" you can find how to access the connector. 2. Go to the next question.
		No	1. Reconnect the sensor connector as described in the "Technical specification" chapter. 2. Follow the procedure for ending the maintenance. 3. Reset the errors as instructed in the chapter "How to reset errors".
3	Is the connection at the sensor correct?	Yes	1. Get the mid-section sensor service set. 2. Replace the sensor as instructed in its supplied manual. 3. Go to the next question.
		No	1. Reconnect the sensor connector. 2. Follow the procedure for ending the maintenance. 3. Reset the errors as instructed in the chapter "How to reset errors".
3	Did the error come back?	Yes	1. Get the main board service set. 2. Replace the main board as instructed in its supplied manual. 3. Follow the procedure for ending the maintenance.

⁴ You can find the correct connection in the "Technical specification" chapter.

Malfunction code EXTERNAL FILTER ALARM.	The external filter is dirty.
--	--------------------------------------

Action

1. Replace or clean the external filter as instructed in its relevant manual.
2. Reset the errors as instructed in the chapter "How to reset errors".
3. Fill in the maintenance log (if present).

Malfunction code FAN_EHA ERROR / FAN_SUP ERROR.	The exhaust / supply air fan has a malfunction. ■ When orientation is RIGHT: FAN_EHA is on the right side; ■ When orientation is LEFT: FAN_EHA is on the left side.		
--	--	--	--

	Question	Answer	Action
1	-	-	1. Access the main board as instructed in the chapter "How to gain access to the main board". 2. Go to the next question.
2	Are the connections at the main board correct? ⁴	Yes	1. Inspect the fan as instructed in the chapter "Maintenance of the fans". 2. Go to the next question.
		No	1. Reconnect the fan as described in the "Technical specification" chapter. 2. Follow the procedure for ending the maintenance. 3. Reset the errors as instructed in the chapter "How to reset errors".
3	Are the connections at the mid-section sensor correct?	Yes	1. Make sure the heat exchanger is installed in the unit. 2. Install a voltmeter on the voltage connector of the fan (AC: black - blue) 3. Connect the power to the unit.  Be aware of the danger for electrical shocks and rotating parts. 4. Reset the errors as instructed in the chapter "How to reset errors". 5. Go to the next question.
		No	1. Reconnect the connectors of the fan . 2. Follow the procedure for ending the maintenance. 3. Reset the errors as instructed in the chapter "How to reset errors".
4	Is there a voltage of approximately 230V on the voltage connector?	Yes	1. Get the fan service set. 2. Replace the fan as instructed in its supplied manual. 3. Follow the procedure for ending the maintenance. 4. Reset the errors as instructed in the chapter "How to reset errors". 5. Go to the next question.
		No	1. Get the main board service set. 2. Replace the main board as instructed in its supplied manual. 3. Follow the procedure for ending the maintenance.
5	Did the error come back?	Yes	1. Get the main board service set. 2. Replace the main board as instructed in its supplied manual. 3. Follow the procedure for ending the maintenance.

Malfunction code GENERAL ERROR xxxxx	An error without description occurred.
---	---

Action

1. Write down the number of the GENERAL ERROR.
2. Contact the supplier and provide them with the noted number.
3. Follow the instructions of the supplier.
4. Follow the procedure for ending the maintenance.

Malfunction code GROUND_HEAT_CONNECT ERROR / POSTHEAT_CONNECT ERROR.	There is no communication between the ComfoFond-L Q / post-heater temperature sensor and the unit.		
---	---	--	--

	Question	Answer	Action
1	Is the ancillary still needed in the system?	Yes	1. Disconnect the power to the unit. 2. Access the option box connectors. 3. Go to the next question.
		No	1. Open the semi-transparent visor. 2. Navigate to PERIPHERALS ERRORS 3. Follow the procedure for ending the maintenance.
2	Are the connections at the option box correct? ⁴	Yes	1. Access the connections on the ancillary side. 2. Follow the procedure for ending the maintenance.
		No	1. Reconnect the ancillary to the option box. 2. Fill in the maintenance log.
3	Are the connections at the ancillary side correct? ⁷	Yes	Go to the next question.
		No	1. Reconnect the ancillary to the option box. 2. Follow the procedure for ending the maintenance.

⁴ You can find the correct connection in the "Technical specification" chapter.



Malfunction code GROUND_HEAT_CONNECT ERROR / POSTHEAT_CONNECT ERROR.		There is no communication between the ComfoFond-L Q / post-heater temperature sensor and the unit.	
	Question	Answer	Action
4	Is something wrong with the NTC sensor of the ancillary?	Yes	1. Get the ComfoCool Q600 NTC supply sensor service set. 2. Replace the sensor. 3. Follow the procedure for ending the maintenance.
		No	Go to the next question.
5	Is something wrong with the cable?	Yes	1. Replace the cable. 2. Follow the procedure for ending the maintenance.
		No	1. Get a new option box. 2. Replace the option box. 3. Follow the procedure for ending the maintenance.

Malfunction code INIT ERROR	The unit has not been commissioned.
--------------------------------	-------------------------------------

Action

- Commission the unit by running the commission wizard.
(See chapters "Commissioning the unit" and "COMMISSIONING menu")
- Reset the errors as instructed in the chapter "How to reset errors".
- Follow the procedure for ending the maintenance.

Malfunction code PREHEAT ERROR.		The pre-heater has a malfunction. ■ When orientation is RIGHT: Preheater is on the left side; ■ When orientation is LEFT: Preheater is on the right side.	
	Question	Answer	Action

1	Are there also sensor errors present?	Yes	Follow the instructions of the SENSOR_ETA ERROR / SENSOR_ODA ERROR / SENSOR EHA ERROR / SENSOR_SUP ERROR table.
		No	1. Inspect the pre-heater as instructed in the chapter "Maintenance of the pre-heater". Keep the unit open after finishing all the maintenance. 2. Connect the power to the unit.  Be aware of the danger for electrical shocks and rotating parts. 3. Reset the errors as instructed in the chapter "How to reset errors". 4. Go to the next question.
2	Did the error come back?	Yes	1. Get the pre-heater service set. 2. Replace the pre-heater as instructed in its supplied manual. 3. Connect the power to the unit.  Be aware of the danger for electrical shocks and rotating parts. 4. Reset the errors as instructed in the chapter "How to reset errors". 5. Follow the procedure for ending the maintenance.
		No	Follow the procedure for ending the maintenance.

Malfunction code PREHEAT_LOCATION ERROR.		The pre-heater is not in the correct location. ■ When orientation is RIGHT: Preheater is on the left side; ■ When orientation is LEFT: Preheater is on the right side.	
	Question	Answer	Action

1	Is the orientation of the unit set correctly? ⁸	Yes	1. Change the location of the pre-heater as instructed in the chapter "How to change the location of the pre-heater". 2. Reset the errors as instructed in the chapter "How to reset errors". 3. Go to the next question.
		No	1. Set the orientation of the unit correct by running the complete commissioning wizard. 2. Reset the errors as instructed in the chapter "How to reset errors".
2	Are there also sensor errors present?	Yes	Follow the instructions of the SENSOR_ETA ERROR / SENSOR_ODA ERROR / SENSOR EHA ERROR / SENSOR_SUP ERROR table.
		No	1. Remove the pre-heater from the unit. 2. Shake the pre-heater thoroughly. 3. Install the pre-heater back into the unit. 4. Reset the errors as instructed in the chapter "How to reset errors". 5. Go to the next question.
3	Did the error come back?	Yes	1. Get the pre-heater service set 2. Replace the pre-heater as instructed in its supplied manual. 3. Follow the procedure for ending the maintenance. 4. Reset the errors as instructed in the chapter "How to reset errors".
		No	Follow the procedure for ending the maintenance.

⁸ You can find the orientation settings in menu > MENU > STATUS > UNIT > HRU TYPE

Malfunction code PREHEAT_PRES ERROR.		There is no communication between the pre-heater and the unit. ■ When orientation is RIGHT: Preheater is on the left side; ■ When orientation is LEFT: Preheater is on the right side.	
	Question	Answer	Action
1	Are there also sensor errors present?	Yes	Follow the instructions of the SENSOR_ETA ERROR / SENSOR_ODA ERROR / SENSOR EHA ERROR / SENSOR_SUP ERROR table.
		No	1. Access the main board as instructed in the chapter "How to gain access to the main board". 2. Go to the next question.
2	Are the connections at the main board correct? ⁴	Yes	1. Get the pre-heater service set. 2. Replace the pre-heater as instructed in its supplied manual. 3. Connect the power to the unit.  Be aware of the danger for electrical shocks and rotating parts. 4. Reset the errors as instructed in the chapter "How to reset errors". 5. Go to the next question.
		No	1. Reconnect the pre-heater connectors. 2. Follow the procedure for ending the maintenance. 3. Reset the errors as instructed in the chapter "How to reset errors".
3	Did the error come back?	Yes	1. Get the main board service set 2. Replace the main board as instructed in its supplied manual. 3. Follow the procedure for ending the maintenance.
		No	Follow the procedure for ending the maintenance.



Malfunction code SENSOR_ETA ERROR / SENSOR_ODA ERROR / SENSOR EHA ERROR / SENSOR_SUP ERROR.		The extract / outdoor / exhaust / supply air sensor has a malfunction. ■ When orientation is RIGHT: SENSOR_ETA is in top of the unit on the right side; SENSOR_SUP is in middle of the unit on the right side; ■ When orientation is LEFT: SENSOR_ETA is in top of the unit on the left side; SENSOR_SUP is in middle of the unit on the left side.	
	Question	Answer	Action
1	Are all SENSOR ERRORS activated?	Yes	1. Access the main board as instructed in the chapter "How to gain access to the main board". 2. Disconnect all sensor connectors from the main board. 3. Connect the power to the unit.  Be aware of the danger for electrical shocks and rotating parts. 4. Reset the errors as instructed in the chapter "How to reset errors". 5. Reconnect one sensor. 6. Wait 2 minutes. 7. Repeat step 5 and 6 until the unit has an error. 8. Solve this error according to its error table. 9. Reset the errors as instructed in the chapter "How to reset errors". 10. Go to the next question.
		No	1. Access the main board as instructed in the chapter "How to gain access to the main board". 2. Go to the next question.
2	Are the connections at the main board correct? ⁴	Yes	If SENSOR_ETA ERROR or SENSOR_ODA ERROR: 1. Remove the top-section sensor as instructed in the chapter "How to gain access to the top-section sensor". 2. Go to the next question. If SENSOR_EHA ERROR or SENSOR_SUP ERROR: 1. Access the mid-section sensor as instructed in the chapter "How to gain access to the mid-section sensor". 2. Go to the next question.
		No	1. Reconnect the sensor connector as described in the "Technical specification" chapter. 2. Follow the procedure for ending the maintenance. 3. Reset the errors as instructed in the chapter "How to reset errors".
3	Is the connection at the sensor PCB correct?	Yes	1. Get the correct sensor service set. 2. Replace the sensor as instructed in its supplied manual. 3. Reset the errors as instructed in the chapter "How to reset errors". 4. Go to the next question.
		No	1. Reconnect the sensor connector. 2. Follow the procedure for ending the maintenance. 3. Reset the errors as instructed in the chapter "How to reset errors".
4	Did the error come back?	Yes	1. Get the main board service set. 2. Replace the main board as instructed in its supplied manual. 3. Follow the procedure for ending the maintenance.

⁴ You can find the correct connection in the "Technical specification" chapter.

Malfunction code SERVICE MODE.		The basic functions of the unit are stopped to enable the required maintenance to be carried out.	
	Question	Answer	Action
1	Are you performing any maintenance?	Yes	Ignore the error and continue the maintenance procedure.
		No	Go to the next question.
2	Is the standby switch connected to the option box closed?	Yes	Open the standby switch.
		No	Stop the SERVICE MODE.

Malfunction code TEMP_HRU		The outdoor air temperature is too high or low.  The unit is switched off.	
	Question	Answer	Action
1	Is or was the temperature between -30°C and +120°C?	Yes	1. Reset the errors as instructed in the chapter "How to reset errors". 2. Go to the next question.
		No	1. Solve the problem causing the extreme temperature. 2. Reset the errors as instructed in the chapter "How to reset errors". 3. Perform all maintenance actions to check if there is permanent damage to the system. 4. Go to the next question.
2	Did the error come back?	Yes	Follow the instructions of the SENSOR_ETA ERROR / SENSOR_ODA ERROR / SENSOR EHA ERROR / SENSOR_SUP ERROR table.

Malfunction code TEMP_SENSOR_ETA ERROR / TEMP_SENSOR_ODA ERROR / TEMP_SENSOR EHA ERROR / TEMP_SENSOR_SUP ERROR.		The extract / outdoor exhaust / supply air temperature sensor is detecting an incorrect temperature.	
	Question	Answer	Action
1	Is or was the temperature between -40°C and +70°C?	Yes	Make sure that the temperature inside the unit is within the allowed temperature range: 1. When the outdoor temperature is within the allowed temperature range: Set the unit to PRESET 3 to speed up the temperature change in the unit. 2. When the temperature inside the unit is within the allowed temperature range: Inspect the heat exchanger as instructed in the chapter "Maintenance of the heat exchanger". 3. Reset the errors as instructed in the chapter "How to reset errors". 4. Go to the next question.
		No	Inspect the heat exchanger as instructed in the chapter "Maintenance of the heat exchanger". 1. Reset the errors as instructed in the chapter "How to reset errors". 2. Go to the next question.
2	Did the error come back?	Yes	1. Inspect the heat exchanger as instructed in the chapter "Maintenance of the heat exchanger". 2. Follow the instructions of the SENSOR_ETA ERROR / SENSOR_ODA ERROR / SENSOR EHA ERROR / SENSOR_SUP ERROR table.
		No	1. Inspect the heat exchanger as instructed in the chapter "Maintenance of the heat exchanger". 2. Follow the procedure for ending the maintenance.

Malfunction code TEMP_SUP_MIN ERROR		The supply air temperature is too low.  the supply fan is switched off for atleast 1 hour, in order to prevent condensation.	
	Question	Answer	Action
1	Is or was the outdoor air temperature below 0°C?	Yes	1. Wait till the outdoor temperature increases above 0°C. 2. Reset the errors as instructed in the chapter "How to reset errors".
		No	Check the return air temperature.
2	Is or was the return air temperature below 12°C?	Yes	1. Increase the return air temperature above 12°C. 2. Reset the errors as instructed in the chapter "How to reset errors".
		No	1. Check if the extract fan is switched on. 2. Go to the next question.
3	Is the extract fan running?	Yes	1. Disconnect the power to the unit. 2. Remove the design front from the unit. 3. Connect the power to the unit.  Be aware of the danger for electrical shocks and rotating parts. 3. Go to the next question.
		No	1. Switch the extract fan on. 2. Reset the errors as instructed in the chapter "How to reset errors".

Malfunction code TEMP_SUP_MIN_ERROR		The supply air temperature is too low.  the supply fan is switched off for atleast 1 hour, in order to prevent condensation.	
	Question	Answer	Action
4	Did the modulating bypass valves move?	Yes	1. Disconnect the power to the unit. 2. Access the main board as instructed in the chapter "How to gain access to the main board". 3. Go to the next question.
		No	1. Get the modulating bypass actuator service set. 2. Replace the modulating bypass actuator as instructed in its supplied manual. 3. Follow the procedure for ending the maintenance. 4. Reset the errors as instructed in the chapter "How to reset errors".
4	Are the connections at the main board correct? ⁴	Yes	1. Inspect the modulating bypass valves as instructed in the chapter "Maintenance of the modulating bypass valves". 2. Go to the next question.
		No	1. Reconnect the modulating bypass actuator connector as described in the "Technical specification" chapter. 2. Follow the procedure for ending the maintenance. 3. Reset the errors as instructed in the chapter "How to reset errors".
5	Is the connection at the modulating bypass actuator correct?	Yes	1. Get the modulating bypass actuator service set. 2. Replace the modulating bypass actuator as instructed in its supplied manual. 3. Follow the procedure for ending the maintenance. 4. Reset the errors as instructed in the chapter "How to reset errors".
		No	1. Reconnect the connector of the modulating bypass valve. 2. Follow the procedure for ending the maintenance. 3. Reset the errors as instructed in the chapter "How to reset errors".

Malfunction code UNBALANCE_ERROR		The airflow balance (or unbalance setting) cannot be guaranteed.  This error will reset automatically when the problem is solved.	
	Question	Answer	Action
1	Is there an error message on the unit display?	Yes	1. Solve the errors as instructed in their relevant troubleshooting table. 2. If the error is still present go to the next question.
		No	Go to the next question.
2	Is there an external unit present which can influence the air pressure in the dwelling (e.g. roof fan)?	Yes	1. Turn off the external unit causing the change in air pressure. 2. If the error is still present go to the next question.
		No	Go to the next question.
3	Are the filters blocked?	Yes	1. Replace the filters 2. If the error is still present go to the next question.
		No	Go to the next question.
4	Are the valves blocked?	Yes	1. Clean the valves 2. If the error is still present go to the next question.
		No	Go to the next question.
5	Is the heat exchanger clogged by dirt?	Yes	1. Clean the heat exchanger 2. If the error is still present go to the next question.
		No	Go to the next question.
6	Is the heat exchanger frozen?	Yes	1. Defrost the heat exchanger 2. If the error is still present go to the next question.
		No	Go to the next question.
7	Is the fan dirty?	Yes	1. Clean the fan 2. If the error is still present go to the next question.
		No	Go to the next question.
8	Are the ventilation ducts blocked?	Yes	1. Clean the ventilation ducts. 2. If the error is still present go to the next question.
		No	Go to the next question.
9	Is there air leakage in the ductwork system?	Yes	1. Solve air leakage 2. If the error is still present go to the next question.
		No	Check the pressure sensors as described in the EXT_PRESSURE_EHA_ERROR / EXT_PRESSURE_SUP_ERROR table.

⁴ You can find the correct connection in the "Technical specification" chapter.

6.12 What to do in the event of a malfunction (or problem) without a malfunction alert (troubleshooting)

Problem:			The display and fans of the unit are off.
	Question	Answer	Action
1	Do you have power in the rest of the dwelling?	Yes	Check the group switches/fuses in the fuse box.
		No	Call your power supplier to report a power out.
2	Is the power in the fuse box turned on?	Yes	<ol style="list-style-type: none"> 1. Open the semi-transparent visor. 2. Pull the cable tray cover forwards. 3. Check the power cable of the unit. (Check unit side and wall side) 4. Go to the next question.
		No	Switch the group in the fuse box on or replace the fuse.
3	Is something wrong with the power cable?	Yes	Replace or reconnect the power cable.
		No	<ol style="list-style-type: none"> 1. Access the main board as instructed in the chapter "How to gain access to the main board". <p> Be aware of the danger for electrical shocks</p> <ol style="list-style-type: none"> 2. Go to the next question.
4	Is a power signal present (230VAC) on the main board?	Yes	<ol style="list-style-type: none"> 1. Remove the top-section sensor connectors 2. Follow the instructions of the SENSOR_ETA ERROR / SENSOR_ODA ERROR / SENSOR_EHA ERROR / SENSOR_SUP ERROR table.
		No	<ol style="list-style-type: none"> 1. If the unit is a ComfoAir Q 350 get a F5010 fuse. Otherwise get a F5015 fuse. 2. Access the main power fuse as instructed in the chapter "How to gain access to the main power fuse of the unit". 3. Replace the main power fuse of the unit. 4. Follow the procedure for ending the maintenance. 5. Reset the errors as instructed in the chapter "How to reset errors".

Problem:			The supply temperature is high in the summer.
	Question	Answer	Action
1	Is the modulating bypass function set to DISABLE? ⁹	Yes	Set the modulating bypass function to AUTO or OPEN. ⁹
		No	Go to the next question.
2	Is the unit in heating season? ¹⁰	Yes	Set the limit RMOT (average outside temperature over 5 days) heat to the correct value. ¹⁰
		No	Decrease the temperature profile. ¹¹

Problem:			The supply temperature is low in the winter.
	Question	Answer	Action
1	Is the modulating bypass function set to OPEN? ⁹	Yes	Set the modulating bypass function to AUTO or DISABLE. ⁹
		No	Go to the next question.
2	Is the unit in cooling season? ¹⁰	Yes	Set the limit RMOT (average outside temperature over 5 days) cool to the correct value. ¹⁰
		No	Increase the temperature profile. ¹¹

Problem:		The spindle has fallen out the modulating bypass actuator (bypass valve is loose in the unit)
Action		
<ol style="list-style-type: none"> 1. Disconnect the power to the unit. 2. If needed: Remove the heat exchanger. 3. If needed: Jam the still connected modulating bypass valve. 4. Connect the power to the unit. 5. Push the spindle firmly to the opening of the modulating bypass actuator until the spindle is fixed again. 6. Disconnect the power to the unit. 7. Jam both connected modulating bypass valves. 8. Connect the power to the unit. 9. Follow the procedure for ending the maintenance. 		

⁹ You can find the modulating bypass settings in menu > MENU > TASK MENU > BYPASS

¹⁰ You can find the current season and the RMOT heat settings in menu > MENU > STATUS > SEASON DETECTION > SEASON

¹¹ You can find the temperature profile setting in menu > MENU > TASK MENU > TEMPERATURE PROFILE

Problem:			There is too much noise.
	Question	Answer	Action
1	Is the noise a whistling noise?	Yes	Locate the air gap and seal it.
		No	Go to the next question.
2	Is the noise a slurping noise?	Yes	1. Check the condensation drain. 2. Go to the next question.
		No	Go to question 4.
3	Has the condensation drain been connected properly?	Yes	Fill the condensation drain.
		No	Reconnect the condensation drain.
4	Is the noise an airflow noise?	Yes	1. Check the valves and/or grilles. 2. Check the filters 3. Go to the next question.
		No	1. Open the fans as instructed in the chapter "Maintenance of the fans". 2. Skip the next question.
5	Do the valves and/or grilles seal onto the air ducts?	Yes	1. Regulate the valves and/or grilles to the required airflow per room. ¹² 2. Inform the residents about the importance of the valve and/or grille settings.
		No	Reinstall the valves and/or grilles.
6	Are the fan bearings damaged?	Yes	1. Get the fan service set. 2. Replace the fan as instructed in its supplied manual.
		No	Set the preset airflow levels lower.

Problem:			There is a water (condensation) leak.
	Question	Answer	Action
1	Does the condensation from the exhaust air duct run into the unit?	Yes	Go to the next question.
		No	Reconnect the exhaust air duct.
2	Is the condensation drain connected correct?	Yes	Clean the condensation drain as instructed in the chapter "Maintenance of the condensation drain".
		No	Reconnect the condensation drain.

Problem:			The ancillary is not working.
	Question	Answer	Action
1	Does the ancillary have a battery?	Yes	Check the battery and replace it when necessary as instructed in its supplied manual.
		No	Go to the next question.
2	Is the ancillary commissioned to the unit?	Yes	Go to the next question.
		No	Commission the ancillary as instructed in its supplied manual.
3	Does the ancillary send a signal when in use?	Yes	Go to the next question.
		No	1. Get a new ancillary. 2. Replace the ancillary.
4	Is the ancillary connected to an option box?	Yes	Go to the next question.
		No	1. Get the main board service set. 2. Replace the main board as instructed in its supplied manual.
5	Does the option box send a signal when the ancillary is in use?	Yes	1. Get the main board service set. 2. Replace the main board as instructed in its supplied manual.
		No	1. Get a new option box. 2. Replace the option box.

Problem:		The correct time is not saved after a power down.
Action		
<ol style="list-style-type: none"> 1. Get a 3V lithium button cell battery with a nominal capacity of 48 mAh. (Type BR1225) 2. Access the main board as instructed in the chapter "How to gain access to the main board". 3. Replace the battery on the main board. 		

Problem:		The unit will not power down completely after removal of the power cord.
Action		
Disconnect all poles of the power supply to the ComfoSplitter.		

Problem:		The fans of the unit vary extensively.
Action		
<p>Make sure the unit has a stable power supply of at least 225V. You can achieve this with a power stabilizer or by connecting modulating equipment (e.g. post-heater) to a separate group in the fuse box.</p>		

