

Zehnder ComfoClima 36 with ComfoAir Q600



ComfoClima 36 with ComfoAir Q600

The Zehnder ComfoClima 36 is the NEW next generation air temperation device designed to help reduce the risk of overheating in homes and supplement heat in the winter. It combines with the ComfoAir Q450 or Q600 and compliments its features to ensure it automatically activates and deactivates to provide a comfortable, healthy and energy-efficient indoor climate. The Zehnder ComfoAir Q, with state of the art design and intelligent technology, regardless of whether you are working on a new build or an old building, with Zehnder comfortable ventilation you have an innovative, tried and tested complete system. It contains features such as its automatic modulating true summer by-pass, world class heat recovery efficiency and integrated humidity sensor to provide a comfortable, healthy and energy-efficient indoor climate.



Example controls - sold separately



Key Benefits

ComfoClima 36

- Up to 2.6kW cooling capacity.
- Up to 2.4kW heating capacity.
- Independently tested cooling and heating capacity to EN 14511 and EN 16573.
- Fully automatic activation of ComfoClima and increased ventilation rate in summer and winter, with automatic enabling due to Climate Switch technology without the need for user intervention.
- Easy and space-saving installation of left or right handed units directly on top of the Zehnder ComfoAir Q600.
- Left or right hand configuration through software alone, no mechanical alteration required.
- Choice of left or right handed condensate trap for flexibility on site.
- No external device required, just utilise the ventilation units ductwork.
- Filtered fresh supply air, not recycled stale air, using ISO Coarse >65% (G4) as standard with the option to upgrade to ISO ePM1 >55% (F7).
- The 3rd generation of air temperation device from Zehnder, with over 5000 previous units sold and successfully installed world wide.
- Integral sensor for activation based on whole house internal temperature, no risk of false readings due to external sensors cited near appliances, radiators or in direct sunlight.
- Simple clean the only maintenance required once every 2 years.
- Front access for ease of service/maintenance or in situ end of life replacement.
- Wi-Fi enabled as standard for use with the ComfoControl app for IOS or Android.

ComfoAir Q600

- World class 96% efficiency.
- 100% full and filtered modulating summer bypass.
- Left or right hand configuration through software alone, no mechanical alteration required.
- Commissioning wizard for a quick and simple set-up process.
- Flow control to maintain commissioned flow rates.
- Adaptive comfort technology.
- Automatic passive temperature boost in summer.
- Humidity boost continuously monitors the humidity level within the home and looks for a man-made spike before boosting the unit, irrespective of distance or dilution.
- Tool free filter access.
- ISO ePM1 >55% (F7) filter option.
- App for installer and end user option.
- Wireless commissioning option.
- Remote access option.
- KNX compatibility option.
- 0-10V input option.
- Internal pre-heater option.
- Post heater control option.
- Enthalpy cube option.
- Passive House certified.

Article Numbers

Description	Product Code
Unit	
Zehnder ComfoClima 36 for Zehnder ComfoAir Q450/600	471 420 080
Zehnder ComfoAir Q600	471 502 023
Zehnder ComfoAir Q600 with pre-heater, right handed	471 502 024
Zehnder ComfoAir Q600 with pre-heater, left handed	471 502 025
Zehnder ComfoAir Q600 with enthalpy exchanger	471 502 026
Controls	
Controls, Zehnder ComfoSense C 67 remote display for Zehnder ComfoAir Q350/450/600, incl. mounting box	655 010 235
Controls, Zehnder ComfoSwitch C 67 speed controller for Zehnder ComfoAir Q350/450/600, incl. mounting box	655 010 255
Controls, ComfoControl RFZ wireless controller for use with ComfoSense 67/C67 (CCRFZ)	655 000 755
Controls, ComfoControl RFZ Timer wireless controller for use with ComfoSense 67/C67	655 000 780
Controls, Zehnder ComfoConnect KNX C for ComfoAir Q350/450/600	655 011 120
Controls, Zehnder ComfoConnect LAN C for ComfoAir Q350/450/600	655 011 100
Controls, Zehnder Option Box with additional connectivity for Zehnder ComfoAir Q350/450/600	471 502 105
Controls, Zehnder ComfoSplitter for ComfoAir Q350/450/600	655 010 275
Zehnder RF-PCB to offer wireless connectivity to the CCRFZ without the use of a ComfoSense C67	400 502 016
Controls, 12V 0-10V CO2 sensor and combined three position switch	655 000 855

Filters

Filter for Zehnder ComfoAir Q350/450/600, ISO Coarse >65% (G4), 2 Pieces	400 502 012
Filter for Zehnder ComfoAir Q350/450/600, ISO Coarse >65% (G4), 10 Pieces	400 502 014
Filter for Zehnder ComfoAir Q350/450/600, ISO Coarse >65% (G4), 50 Pieces	400 502 021
Filter for Zehnder ComfoAir Q600, ISO Coarse >65% / ISO ePM1 >55% (G4 / F7), 2 Pieces	400 502 013
Filter for Zehnder ComfoAir Q600, ISO ePM1 >55% (F7), 10 Pieces	400 502 015
Filter for Zehnder ComfoAir Q600, ISO ePM1 >55% (F7), 50 Pieces	400 502 022

Support Frame

Support frame for Zehnder ComfoAir Q350/450/600, height 252 mm	471 502 008
--	-------------

Accessories

Heat exchanger for Zehnder ComfoAir Q350/450/600	400 502 008
Enthalpy exchanger for Zehnder ComfoAir Q350/450/600	400 502 010
Condensation water drain kit for Zehnder ComfoClima	736 000 085
Adaptor for ComfoClima 36 to steel ducting ø 200mm with gasket seals, galvanised	990 326 356
Steel ducting ø 215mm to ø 200mm reducer for ComfoClima 36, galvanised	CR215200
Zehnder ComfoPipe ø 200 mm, 45° bend	990 328 697

SAP PCDB

	SFP (W/l/s)		Efficiency (%)	
	2009	2012	2009	2012
K+1	-	0.63	-	96%
K+2	0.63	0.60	96%	95%
K+3	0.57	0.63	95%	94%
K+4	0.57	0.71	95%	94%
K+5	0.61	0.79	94%	93%
K+6	0.67	0.91	94%	93%
K+7	0.75	1.06	94%	93%

SEC Class



Based on average climate with local demand control

Passive House Certification

	Standard heat exchanger	Enthalpy heat exchanger
Air flow range	70–460 m³/h	70–460 m³/h
Heat recovery rate	HR = 87%	HR = 80%
Specific electric power	Pel,spec = 0.24 Wh/m³	Pel,spec = 0.22 Wh/m³
Humidity recovery		x = 68%



Pressure Curve

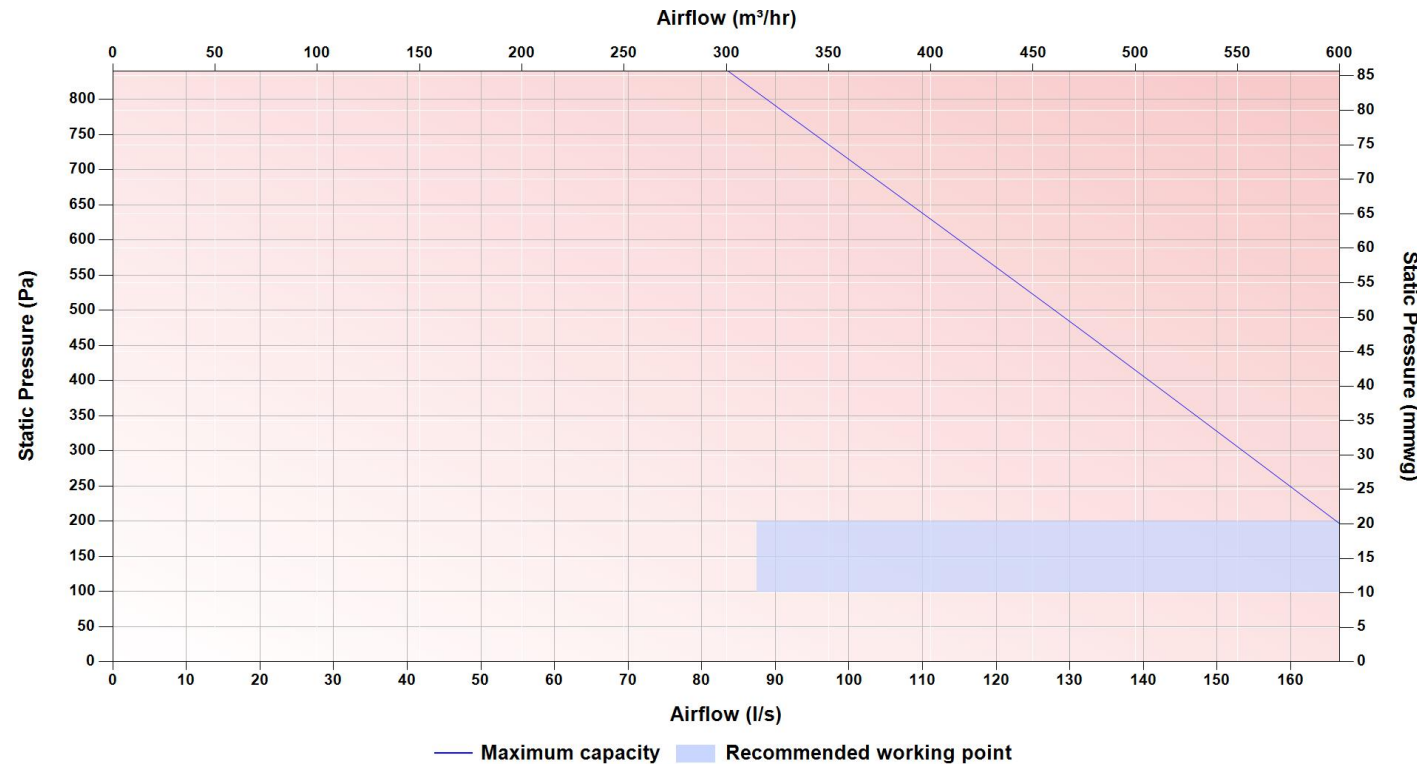

Resistance Guard cap at 400Pa

Sound Data

Speed	Test area	Octave Band (Hz) Sound Power Level, dB								dB(A) @ 3 m
		63	125	250	500	1000	2000	4000	8000	
20%	Casing ComfoClima on	34.0	43.9	49.1	35.1	28.6	22.4	12.9	16.3	24.0
	Supply ComfoClima off	53.4	45.7	47.7	40.5	29.5	18.4	10.0	11.4	
	Supply ComfoClima on	56.4	48.7	50.7	43.5	32.5	21.4	13.0	14.4	
40%	Extract ComfoClima on	57.0	45.2	47.3	33.9	21.0	11.8	12.7	19.5	28.9
	Casing ComfoClima on	49.0	48.7	52.4	43.9	36.6	31.1	23.2	21.8	
	Supply ComfoClima off	62.3	52.1	54.0	48.9	37.3	27.8	20.7	18.8	
60%	Supply ComfoClima on	65.3	55.1	57.0	51.9	40.3	30.8	23.7	21.8	34.9
	Extract ComfoClima on	64.6	50.6	51.9	41.8	28.1	20.9	19.8	21.7	
	Supply ComfoClima on	73.6	61.1	63.0	59.8	47.7	39.7	33.7	28.7	
80%	Casing ComfoClima on	63.1	53.2	55.6	52.1	44.2	39.3	32.9	26.9	41.5
	Supply ComfoClima off	70.6	58.1	60.0	56.8	44.7	36.7	30.7	25.7	
	Supply ComfoClima on	71.8	55.6	56.3	49.3	34.9	29.4	26.4	23.7	
100%	Extract ComfoClima on	78.5	60.3	60.4	56.3	41.3	37.4	32.6	25.7	44.0
	Casing ComfoClima on	76.4	57.5	58.6	59.9	51.3	47.1	42.1	31.8	
	Supply ComfoClima off	78.6	63.8	65.6	64.3	51.7	45.1	40.3	32.3	
100%	Supply ComfoClima on	81.6	66.8	68.6	67.3	54.7	48.1	43.3	35.3	44.0
	Extract ComfoClima on	81.0	58.9	59.6	62.6	53.8	49.7	45.3	33.5	
	Supply ComfoClima on	84.3	68.7	70.5	69.9	57.1	51.0	46.6	37.6	
100%	Extract ComfoClima on	80.9	62.0	61.8	58.8	43.5	40.1	34.8	26.4	

Casing, supply and extract tested according to ISO 3741:2010 showing induct sound power level corrected for end duct reflection according EN 13053:2019. Casing dB(A) @ 3 m given as hemispherical.

Technical Specification

Weight (ComfoClima / Combined with ComfoAir Q600)	62 / 112 Kg
Ducting ø	Internal - 215 mm
Condensate connection ø	32 mm
Filter grade	Standard - ISO Coarse >65% / ISO Coarse >65% (G4 / G4) / Optional - ISO Coarse >65% / ISO ePM1 >55% (G4 / F7)
Materials	Internal EPP / ABS / External coated sheet steel
ComfoClima	
Supply voltage	230 V / single-phase / 50Hz
Maximum power consumption	1100 W
Current draw	4.87 A
Fuse rating	6 amp
Refrigerant	R32
Refrigerant volume	0.65 kg
EER	up to 3.59
Cooling capacity	Up to 2.6 kW
Heating capacity	Up to 2.4 kW
Global Warming Potential (AR4)	675

ComfoAir Q600	
Supply voltage	230 V / single-phase / 50Hz
Maximum power consumption including / excluding pre-heater	2620 W / 350 W
Current draw including / excluding pre-heater	12.7 A / 2.77 A
Fuse rating including / excluding pre-heater	13 / 3 amp
Specific Fan Power	0.48 W/l/s
Heat Recovery Efficiency	0.96
Preheater power	2.2 kW

Dimensions

Height with / without turnable bends	2027 / 1951.4 mm
Width with / without turnable bends	859 / 720.7 mm
Depth	570 mm

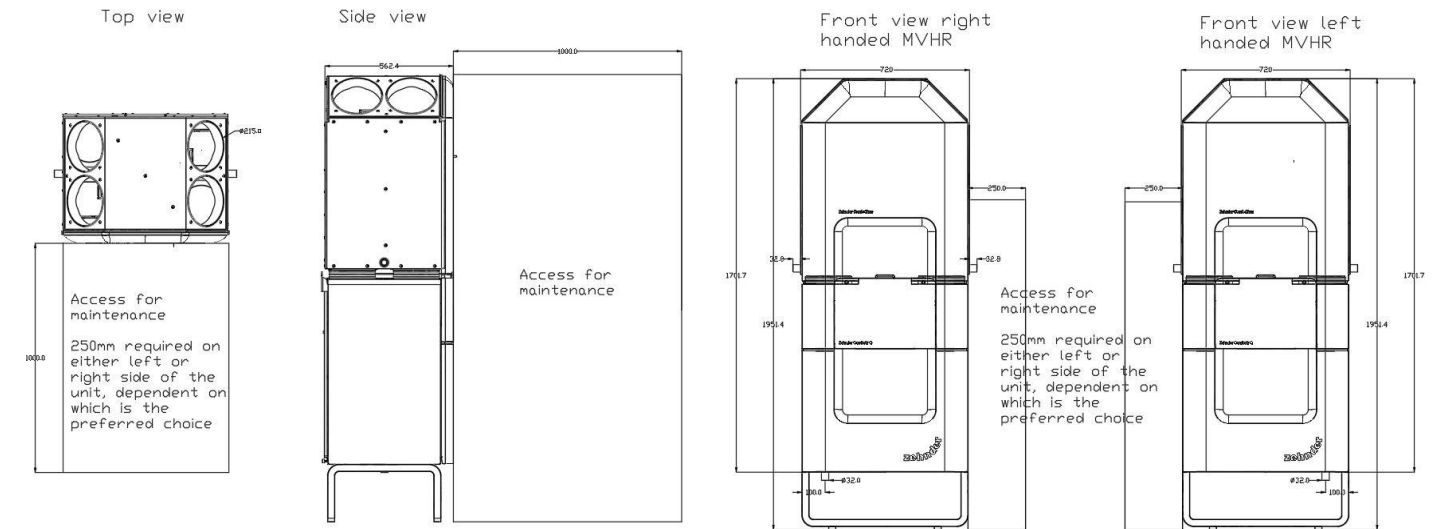

Performance Data

Air temperature							
External conditions		Internal conditions		Air flow l/s / m³hr	Power IN W	COP/EER	Cooling capacity W
Dry bulb temp °C	Wet bumb temp °C	Dry bulb temp °C	Wet bumb temp °C				
35	24	27	19	87 / 315	416	2.68	1116
				116 / 420	592	2.94	1744
				166 / 600	928	2.86	2657
31	22	27	19	87 / 315	375	3.02	1133
				116 / 420	553	3.21	1774
				166 / 600	807	3.2	2581
27	19	27	19	87 / 315	347	3.31	1149
				116 / 420	492	3.47	1706
				166 / 600	688	3.59	2468

Supplementary heating							
External conditions		Internal conditions		Air flow l/s / m³hr	Power IN W	COP/EER	Heating capacity W
Dry bulb temp °C	Wet bumb temp °C	Dry bulb temp °C	Wet bumb temp °C				
-7	-8	20	12	87 / 315	830	1.89	1567
				116 / 420	749	2.21	1654
				166 / 600	824	2.35	1938
2	1	20	12	87 / 315	665	2.42	1609
				116 / 420	651	2.67	1738
				166 / 600	738	3.06	2261
7	6	20	12	87 / 315	709	2.64	1872
				116 / 420	801	2.77	2221
				166 / 600	741	3.29	2441

Capacities tested according to EN 14511 and EN 16573 within a climatic chamber

Air Direction/Connection

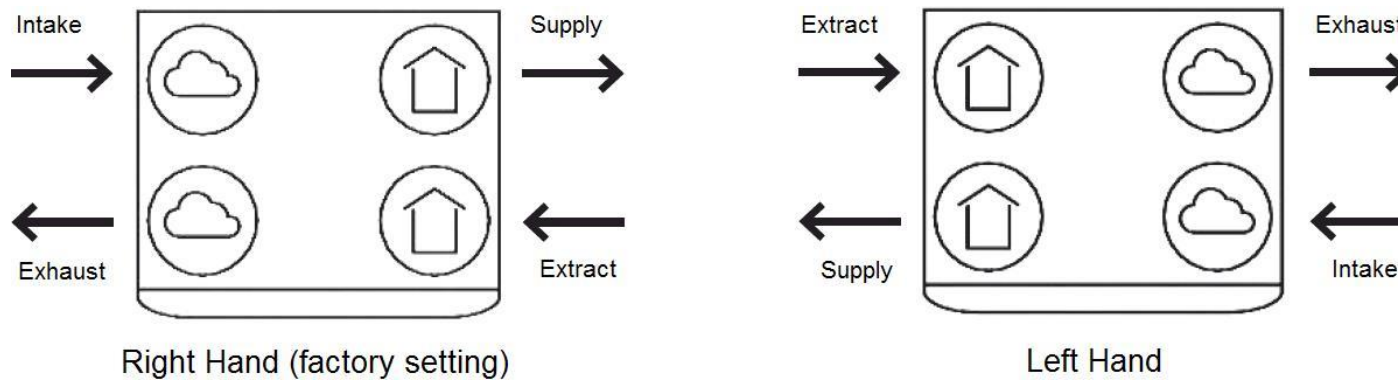

Wiring

Electrical connections should be carried out in accordance to IEE regulations by a qualified electrician. The unit is supplied with a flying lead for connection to the mains supply.

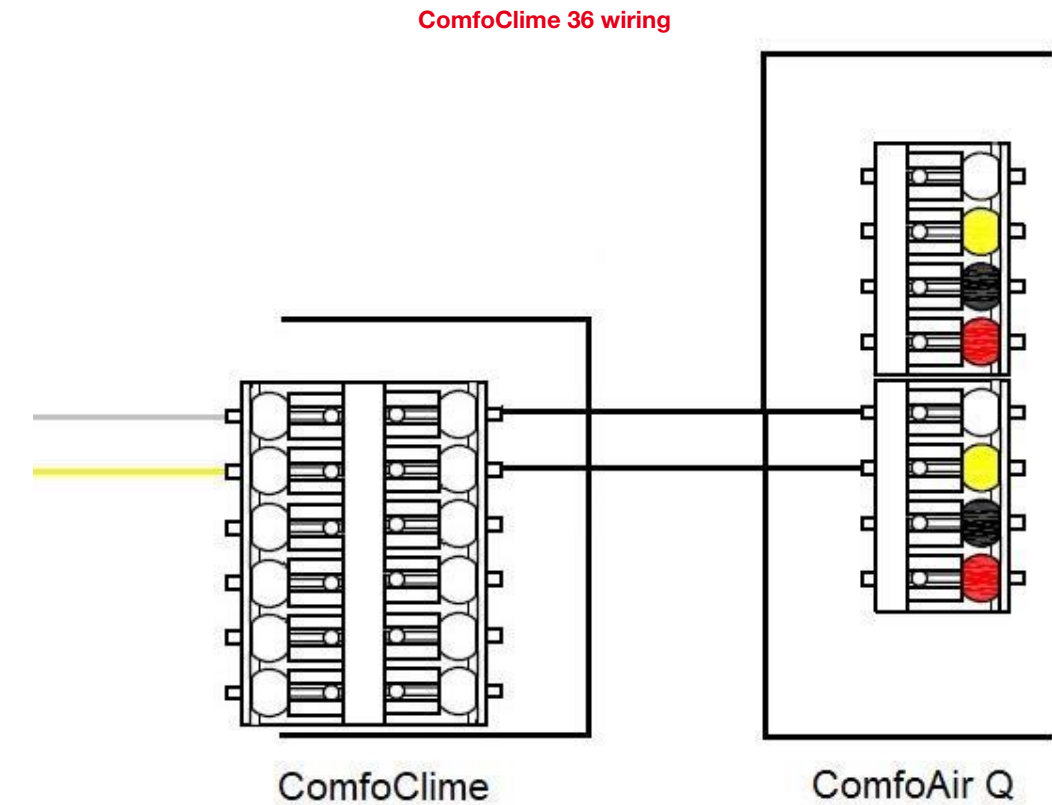

2 core cable, 1.5mm Max.
(up to 50 metres)

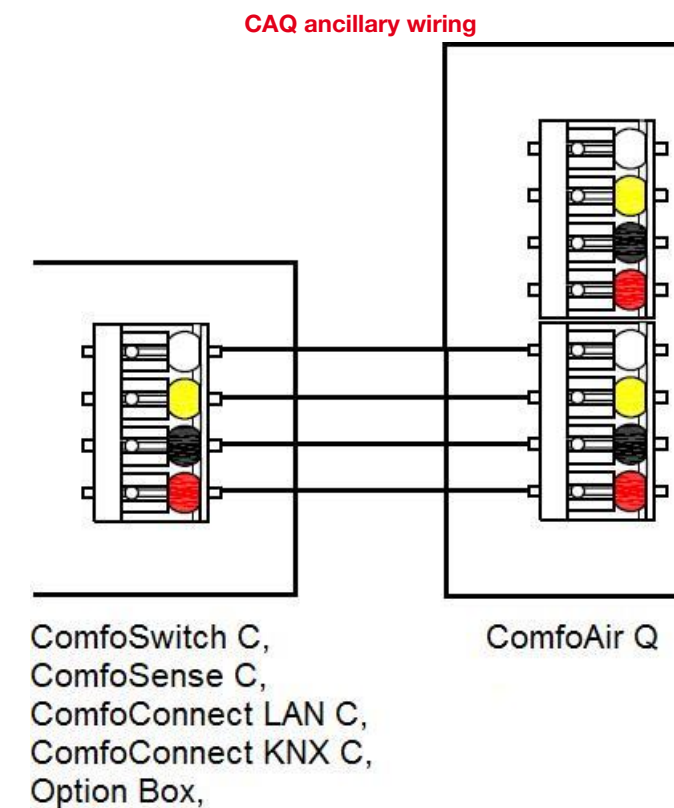

4 core cable, 1.5mm Max.
(up to 50 metres)

Adaptor for ComfoClime 36 to steel ducting ø 200mm with gasket seals, galvanised

Article number: 990 326 356

Description

Adaptor:

Galvanised steel adaptor ø 215 mm ducting to ø 200 mm. The rigid adaptor with attenuation properties can be placed into the ComfoClime 36 spigot to convert it to ø 200 mm ductwork where existing ComfoCool Q design width restrictions are in place. One adaptor is required per side.

Technical Specification

Height	261 mm
Width	226 mm
Depth	485 mm
Weight	4.9 kg



Dimensions

Front View

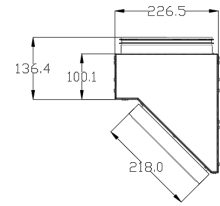

Side View

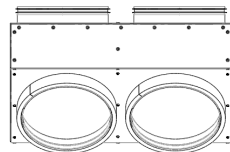

Top View

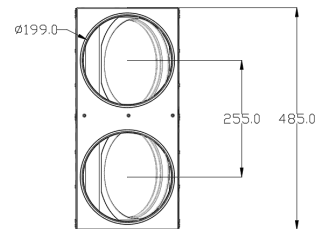

Pressure Curve

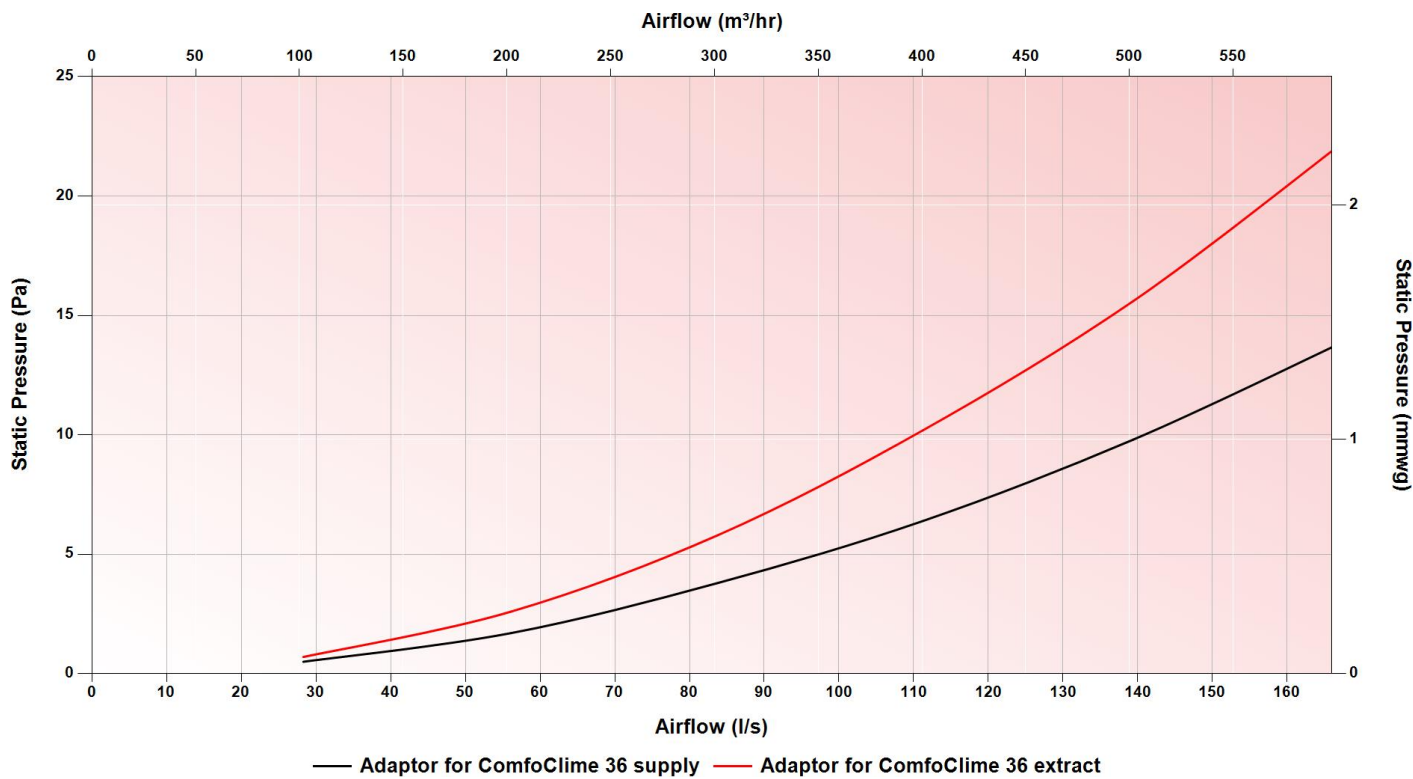

Steel ducting ø 215 mm to ø 200 mm reducer for ComfoClime 36, galvanised

Article number: CR215200

Description

Reducer:

Steel ø 215 mm ducting to ø 200 mm convertor. The rigid connector can be placed into the ComfoClime 36 spigot to convert it to ø 200 mm ductwork where existing ComfoCool Q design width restrictions are in place. One connector is required per spigot.

Technical Specification

Diameter	200 - 215 mm
Weight	0.3 kg



Zehnder ComfoPipe ø 200 mm, 45° bend

Article number: 990 328 697

Description

Insulated bend:

Insulated bend available in 45°, two can be combined to form 90°. Each bend comes complete with a premoulded single male connector to securely connect to a straight length of insulated duct or another 45° bend. Can connect directly to the top of the ComfoClime 36. One connector is required per spigot.

Technical Specification

Angle	45°
Outside diameter	230 mm
Inside diameter	200 mm
Height	286.2 mm
Width	280.9 mm
Depth	230 mm
Weight	0.08 kg



Dimensions

Front View

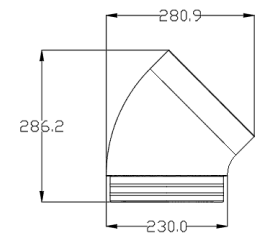

Side View

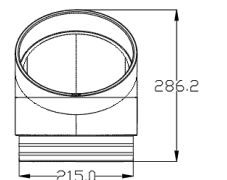

Top View

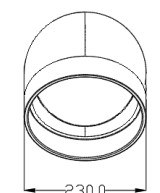

Controls

ComfoSense C67

Product code: 655 010 235



The Zehnder ComfoSense C67 is a four position switch designed to enable the user to manually select the desired ventilation systems flow rate and provide system notifications

Key Benefits

- 4 separate ventilation flow rate options to select in 1 controller
- 7 day flow rate programmer
- Summer bypass indicator
- Frost protection indicator
- Service and Maintenance alert
- Clock function
- User menu access
- RF bridge to enable use of the CCRFZ (655 000 755) controller

Technical Specification

Mounting options	Recessed / Surface
Supply voltage	Low voltage direct from the MVHR units ComfoNET connector
IP rating	IP44
Recommended cable	4 core cable, 1 mm Max. (up to 50 metres)
RAL colour	9016
Maximum number per unit	2 (3/6 if using ComfoSplitter unpowered/powered)

Dimensions (recessed)

Height	80 mm
Width	80 mm
Depth	12 mm

Dimensions (surface mounted)

Height	80 mm
Width	80 mm
Depth	48.5 mm

ComfoSwitch C67

Product code: 655 010 255



The Zehnder ComfoSwitch C67 is a four position switch designed to enable the user to manually select the desired ventilation systems flow rate and provide system notifications

Key Benefits

- 4 separate ventilation flow rate options to select in 1 controller
- Temporary high speed activation setting
- Service and Maintenance alert

Technical Specification

Mounting options	Recessed / Surface
Supply voltage	Low voltage direct from the MVHR units ComfoNET connector
IP rating	IP44
Recommended cable	4 core cable, 1 mm Max. (up to 50 metres)
RAL colour	9016
Maximum number per unit	2 (3/6 if using ComfoSplitter unpowered/powered)

Dimensions (recessed)

Height	80 mm
Width	80 mm
Depth	12 mm

Dimensions (surface mounted)

Height	80 mm
Width	80 mm
Depth	48.5 mm

ComfoControl RFZ

Product code: 655 000 755



The Zehnder CCRFZ is a three position switch designed to enable the user to manually select the desired ventilation systems flow rate and provide system notifications. This controller can only be used in conjunction with the ComfoSense or ComfoSense C.

Key Benefits

- Wireless controller
- 3 separate ventilation flow rate options to select in 1 controller
- 2 temporary high speed activation settings
- Service and Maintenance alert

Technical Specification

Mounting options	Surface
Supply voltage	Powered by a coin cell lithium battery (type: CR 2032)
IP rating	IP40
RAL colour	9010
Maximum number per unit	40

Dimensions (surface mounted)

Height	80 mm
Width	80 mm
Depth	14 mm

ComfoControl RFZT

Product code: 655 000 780



The Zehnder CCRFZT is a multi position switch designed to enable the user to manually select the desired overrun timer duration. This controller can only be used in conjunction with the ComfoSense or ComfoSense C.

Key Benefits

- Wireless controller
- 3 separate ventilation overrun timer options to select in 1 controller
- Manual override to prematurely turn off the overrun timer
- Controller service and connection alert

Technical Specification

Mounting options	Surface
Supply voltage	Powered by a coin cell lithium battery (type: CR 2032)
IP rating	IP40
RAL colour	9010
Maximum number per unit	40

Dimensions (surface mounted)

Height	80 mm
Width	80 mm
Depth	14 mm

ComfoConnect KNX C

Product code: 655 011 120



The Zehnder ComfoConnect KNX C enables the connection between the ventilation system and the KNX building management system.

Key Benefits

- Control and monitor the ventilation system via the KNX building management system
- Control ventilation flow rate, temperature profile, temporary high speed setting and external sensor set points
- Monitor ventilation flow rates, temperatures and external sensors
- 7 day flow rate programmer
- Service and Maintenance alert
- ETS5 compatible

Technical Specification

Supply voltage	Low voltage direct from the MVHR units ComfoNET connector
IP rating	IP30
Recommended cable	4 core cable, 1 mm Max. (up to 50 metres)
RAL colour	Front: 9003 Back: 7024
Device model	System B
Supported configuration mode	S-Mode
Supported ETS version	5
Zehnder KNX library available at	https://www.zehnder.co.uk
Maximum number per unit	1

Dimensions (surface mounted)

Height	120 mm
Width	76 mm
Depth	25 mm

ComfoConnect LAN C

Product code: 655 011 100



The Zehnder ComfoConnect LAN C enables the connection between the ventilation system and the ComfoControl app for iPhone and android devices.

Key Benefits

- Control and monitor the ventilation system via the ComfoControl app
- Control ventilation flow rate, temperature profile, temporary high speed setting and external sensor set points
- Monitor ventilation flow rates, temperatures and external sensors
- 7 day flow rate programmer
- Access the ventilation system remotely from anywhere in the world
- Service and Maintenance alert direct to your phone
- User menu access
- Installer menu access



Zehnder ComfoControl App

Technical Specification

Supply voltage	Low voltage direct from the MVHR units ComfoNET connector
IP rating	IP30
Recommended cable	4 core cable, 1 mm Max. (up to 50 metres)
RAL colour	Front: 9003 Back: 7024
Maximum number per unit	1

Dimensions (surface mounted)

Height	120 mm
Width	76 mm
Depth	25 mm

Option Box

Product code: 471 502 105



The Zehnder Option Box enables the connection between the ventilation system and various other external components.

Key Benefits

- 4 x 0-10V inputs for use with the 12V 0-10V RH sensor or 12V 0-10V CO2 sensor
- Volt free contact input
- Post heater integration
- ComfoFond-L Q or sub-soil heat exchanger valve integration
- External filter alert integration
- Service mode activation input to disable fans e.g. when fire alarm activated

Technical Specification

Supply voltage	Low voltage direct from the MVHR units ComfoNET connector Mains power - 230 V / single-phase / 50Hz
IP rating	IP40
Recommended cable	4 core cable, 1 mm Max. (up to 50 metres)
RAL colour	9018
Maximum number per unit	1

Dimensions (surface mounted)

Height	253 mm
Width	178 mm
Depth	60 mm

Wiring

The Bathroom Switch connection option - II

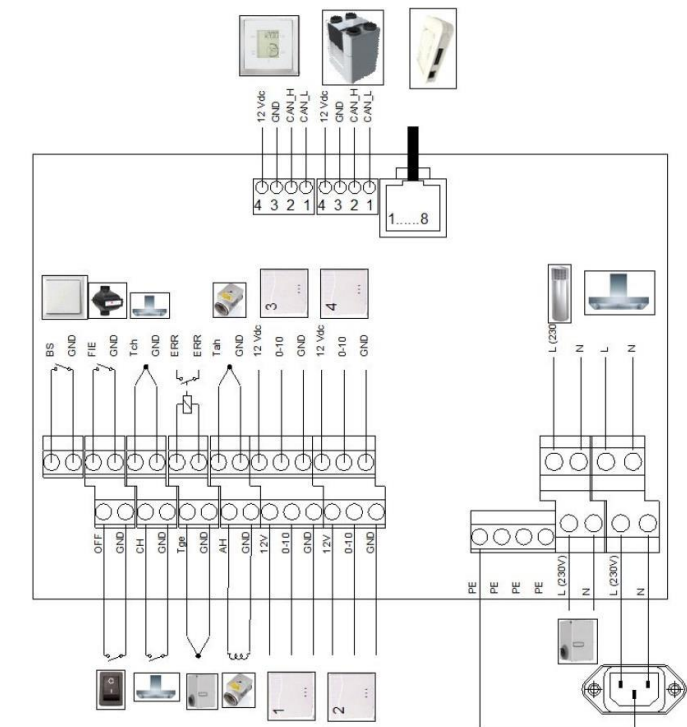
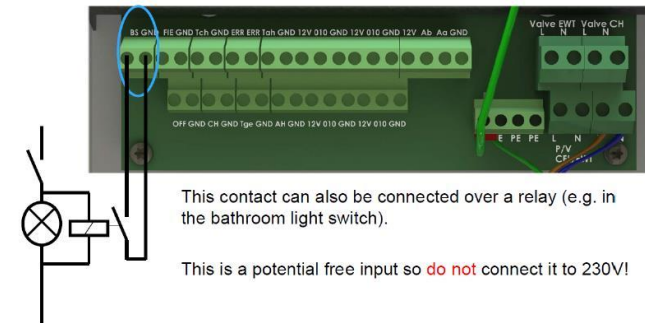

ComfoSplitter

Product code: 655 010 275



The Zehnder ComfoSplitter enables 5 additional ComfoNet connectivity options to the ventilation system.

Key Benefits

- 2 additional ComfoNet connectivity options when unpowered
- 5 additional ComfoNet connectivity options when powered

Technical Specification

Mounting options	Surface
Supply voltage	Low voltage direct from the MVHR units ComfoNET connector Mains power - 230 V / single-phase / 50Hz
IP rating	IP22
Recommended cable	4 core cable, 1 mm Max. (up to 50 metres)
RAL colour	9018
Maximum number per unit	1

Dimensions (surface mounted)

Height	108 mm
Width	53 mm
Depth	23 mm

12V 0-10V CO2 sensor

Product code: 655 000 855



The Zehnder 12V 0-10V remote CO2 sensor and combined three position switch is designed to enable the user to manually select the desired ventilation systems flow rate based on the visual air quality indicator, or automatically adjust the unit relevant to the CO2 level.

Key Benefits

- Green, orange and red visual air quality indication light
- 3 separate ventilation flow rate options to temporarily select in 1 controller for manual 12hr override
- CO2 measuring range 0-2000 ppm
- 0-10V output corresponding to measured CO2
- Discreet design

Technical Specification

Mounting options	Surface / Recessed
Supply voltage	12 V DC voltage direct from the MVHR units PCB connector
IP rating	IP30
Recommended cable	4 core cable, 1 mm Max. (up to 50 metres)
RAL colour	9016

Dimensions (recessed)

Height	80 mm
Width	80 mm
Depth	12 mm

Dimensions (surface mounted)

Height	80 mm
Width	80 mm
Depth	43.5 mm

RF-PCB - ComfoAir Q

Product code: 400 502 016

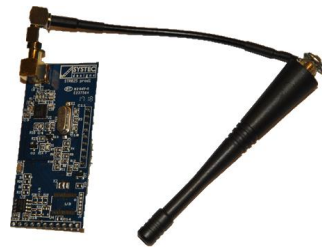

The Zehnder RF-PCB enables the CCRFZ (655 000 755) controller to be used with the ventilation system without the need for the ComfoSense C67.

Key Benefits

- Acts as a wireless receiver to the CCRFZ (655 000 755) controller without the need for the ComfoSense C67
- Built into the unit and not visible from the outside

Technical Specification

Mounting options	Inside the unit direct to the PCB
------------------	-----------------------------------

For use with

Our range of ComfoClime units can be used in conjunction with our ComfoWell 520 or 625 and ComfoTube Therm. The modular ComfoWell manifold can be combined with multiple circular connections for rigid round or semi-rigid connections. Along with filter boxes and attenuated manifold options, the ComfoWell is the perfect bespoke air distribution system for our ComfoAir MVHR units. The ComfoTube Therm has been specifically designed to reduce energy loss when transporting tempered air, to enable energy-efficient cooling and heating whilst maintain the flexibility of the ComfoTube semi-rigid ductwork..

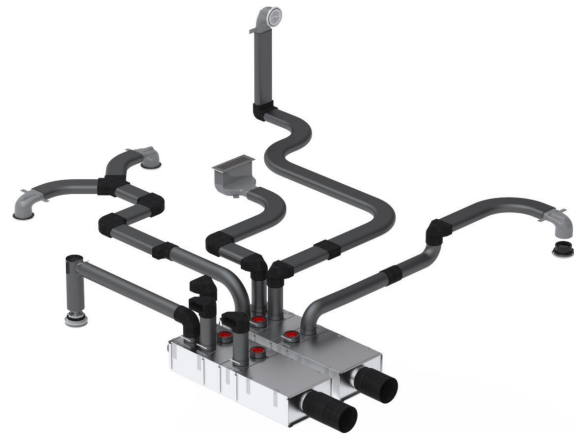

TO VIEW OUR COMFOTUBE THERM INFORMATION

CLICK HERE

BIM/CAD Components

If you would like to download the BIM / CAD files for this or any other of our products then please visit our BIM library.

TO VISIT OUR BIM/CAD LIBRARY

CLICK HERE

Installation Instructions

If you would like to download the installation files for this or any other of our products then please visit our download page by clicking the link below.

TO VISIT OUR DOWNLOAD PAGE

CLICK HERE

Our Informational Videos



Watch our video on how to install the Zehnder ComfoAir Q.

TO WATCH OUR VIDEO

CLICK HERE



Watch our video on how to install the Zehnder ComfoClime.

TO WATCH OUR VIDEO

CLICK HERE

Consultant Specification

Specification

The units shall consist of a body manufactured in powder coated steel. The units shall be fully insulated using high quality EPP to maintain excellent thermal and acoustic characteristics and prevent shrinkage over time. The air temperation unit shall be capable of working in conjunction with the whole house ventilation system with heat recovery ComfoAir Q450 or Q600, utilising the fresh and filtered external air. The air temperation unit shall temper the supply air from the ComfoAir Q450 or Q600 unit utilising a compression air temperation system. The air temperation unit shall contain a low toxicity, low flammability and zero ozone depletion coolant R32. The cooling and heating capacity must be independently tested to [EN 14511](#) and [EN 16573](#).

The air temperation unit shall be controlled by the average return temperature from the ComfoAir Q450 or Q600 unit.

The air temperation unit shall be constructed to have a removable cover to allow full maintenance access. The removable cover shall enable access to the electrical connections, sensors and cooling skid. The spare parts must be made available for a minimum of 10 years even after ceasing manufacture of the unit.

The ventilation unit shall have DC motors with sealed for life bearings. The fans impellers should be low pressure centrifugal type with backward curved blades within ABS scroll housing and flow ring to provide accurate pressure measurement and incorporate a flow grid to optimise the airflow into the fan. The heat exchanger shall be a diamond shaped multi-plate, counter flow design constructed from Polystyrene with laser welded joints and shall retain up to 96% of the temperature differential of outgoing air with the option to upgrade to an enthalpy heat exchanger for latent and sensible heat transfer plus moisture recovery negating the need for a condensate drain.

The ventilation unit shall contain filters manufactured from recyclable material which has been tested to a minimum of [ISO Coarse](#) >65% (G4) standard with the option to upgrade to [ISO ePM1](#) >55% (F7). The filters shall be pleated to reduce the pressure drop and required cleaning time. The ventilation unit shall have 180 mm duct connections, and be suitable for vertical wall mounting or floor stand with the ability to allow left or right hand configuration through the unit's software alone – no mechanical reconfiguration shall be required. Integrated modulating preheater options shall be available to regulate its output to enable balanced ventilation with external air temperatures -10°C.

The ventilation unit shall contain filters manufactured from recyclable material which has been tested to a minimum of [ISO Coarse](#) >65% (G4) standard with the option to upgrade to [ISO ePM1](#) >55% (F7). The filters shall be pleated to reduce the pressure drop and required cleaning time. The ventilation unit shall have 180 mm duct connections, and be suitable for vertical wall mounting or floor stand with the ability to allow left or right hand configuration through the unit's software alone – no mechanical reconfiguration shall be required. Integrated modulating preheater options shall be available to regulate its output to enable balanced ventilation with external air temperatures -10°C.

The ventilation unit shall have a 100% full summer bypass using an in-line modulating mechanism to provide filtered supply air 365 days of the year, even under bypass conditions. It shall provide fresh filtered air to aid night time cooling and prevent condensation within the supply pipework, regardless of the external air temperature. The ventilation unit shall contain a temperature sensor for each air stream to ensure correct and logical operation of the bypass damper by evaluating differential as well as absolute temperature to maximise the opportunity for free cooling. The ventilation unit shall control air flow to react to prolonged, sustained increased pressure drops to best achieve the commissioned flow rate even when filter degradation occurs.

Airflow should not react to short term 'wind gusts' to avoid nuisance running.

The ventilation unit shall be constructed to have a removable cover to allow full maintenance access. The removable cover shall enable access to the supply/extract fan, heat exchanger and access to electrical connections. The motors shall be suitable for removal without the requirement for the unit to be removed from situ and be available as spare parts for a minimum of 10 years even after ceasing manufacture of the unit.

The units shall conform to LVD and EMC standards and be CE Marked in addition to having an EU compliant energy rating label (SEC) with a minimum grade of A. The units shall conform to [UK Electrical Equipment \(Safety\) Regulations](#) and [Electromagnetic Compatibility Regulations](#) and be UKCA Marked. The units shall be manufactured by Zehnder.

Consultant Specification

Operation

The air temperation unit shall be a ComfoClime 36 manufactured by Zehnder and shall be suitable to mount directly onto a ComfoAir Q450 or Q600 supply and extract unit mounted onto a floor stand in accordance with the specification.

The air temperation unit shall remove heat energy and moisture from the supply air in summer. The heat energy shall be transferred from the supply air to the exhaust air and directed to outside via the ComfoAir Q450 or Q600 system with enthalpy cube. In the winter the unit shall provide supplementary heating to the supply air. The units shall not require external units but instead only rely on the intake and exhaust terminations of the ComfoAir Q450 or Q600 unit. The dehumidification of the air creates condensation which shall be drained to the waste water system.

The air temperation unit shall have the ability to activate or deactivate automatically based on the selected temperature profile with the ability to automatically increase the ventilation rate if required. The air temperation option shall only activate automatically in summer and automatically disable during the winter months, with the heated air option automatically activated in winter and disabled during the summer. The supply and extract ventilation unit shall be a ComfoAir Q manufactured by Zehnder and shall be suitable to mount on a floor stand, wall or in a cupboard in accordance with the specification.

The fresh filtered air from outside shall be supplied to each of the habitable rooms and pre-heated by the warm extract air from the wet areas, such as kitchen or bathroom, via the plastic counter flow heat exchanger. The ventilation unit shall vary its speed of the EC motors automatically when it receives a signal from one of the inbuilt sensors or via external switches.

Controls

The ComfoClime unit shall contain the following functions within the unit pre-wired and factory fitted by the manufacturer:

- Temperature sensors to monitor internal and external conditions in addition to the supply air to determine when to activate

All ComfoAir Q units shall contain the following functions within the unit pre-wired and factory fitted by the manufacturer:

- Dial-a-duty motor control
- 4 Variable speed flow rate set points
- Automatic filtered modulating summer bypass with timed manual override option
- Heat exchanger frost protection
- Commissioning wizard to enable commissioning of the unit
- Integral service, fault and operation indicators
- Control panel PIN protection
- Tool free filter access
- Humidity sensors to operate the unit in response to humidity spikes above natural background humidity levels as opposed to a single threshold humidity point to activate the high set point
- Automatic passive boost for night time cooling
- Variable overrun timer relative to high speed activation period

All ComfoAir Q units shall contain the following options when combined with relevant ancillaries:

- BMS compatibility via KNX protocol option (ComfoConnect KNX C)
- Wi-Fi connectivity option (ComfoConnect LAN C)
- RFZ wireless connectivity option (RF-PCB or ComfoSense C 67)
- Switched live input option (Option Box)
- Volt free contact option (Option Box)
- 0-10V input option (Option Box)
- Pre-heater frost protection option
- Post-heater control option (Option Box)
- Control input for single or multiple capacitive touch speed controllers with 7 day programmer capabilities (ComfoSense C 67)
- Control input for single or multiple 4 speed manual/auto controller with filter alert (ComfoSwitch C 67)