

## **ComfoAir 155 WM**

Mechanical Ventilation with Heat Recovery

### **User / Homeowner Guide**



CA155WM-GB

# Contents

User / Homeowner Information	Page
1.0 Ventilation In Your Home .....	2
2.0 General Overview .....	3
3.0 Controls .....	4
4.0 Servicing and Maintenance .....	8
5.0 Commissioning and Inspection Record .....	15
6.0 Guarantee .....	20

## 1.0 Ventilation In Your Home

1.1 Your home has a Heat Recovery Ventilation System installed. This consists of a continuously running Supply and Extract System with Heat Recovery that is linked by a network of ducts to extract air on a continual basis from the following areas (referred to as "wet rooms") in residential dwellings:

- Kitchen
- Utility Room
- WC/Cloakroom
- Ensuite Bath/Shower Room

And supply air continually to:

- Living Room
- Dining Room
- Bedroom
- Study

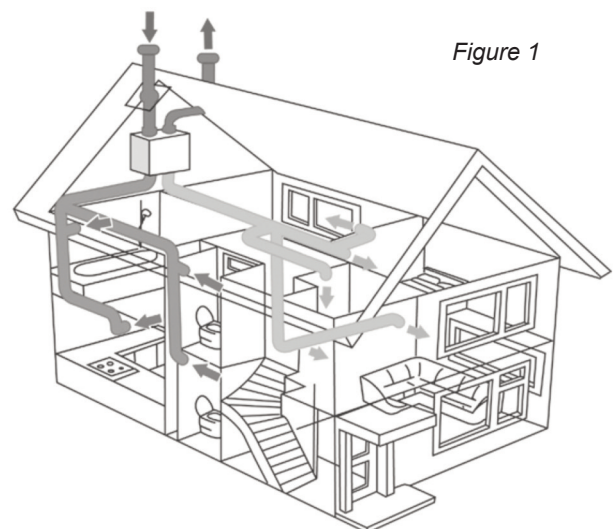

Figure 1

## 2.0 General Overview

2.1 The product incorporates a Heat Exchanger that recovers the heat energy from the "extract air" that would normally be lost with other ventilation systems. It does this using minimal power consumption as the product uses EC low energy motors.

2.1.1 Depending on the way your ComfoAir 155 WM unit has been installed, the specific operation may vary.

The unit has either two or three speeds available:

2 - Speed	Low Speed High Speed	Operating on a continual basis
3 - Speed	Low Speed	Activating manually using either our ZGS1 or ZGS2 switch
	AUX Speed	Activating manually using either our ZGS1 / ZGS2 switch
	High Speed	Activating manually using either our ZGS1 / ZGS2 switch, via 'switch-live' or via our ZGRC1 boost and status controller

ZGS2 switch markings: Low (I) & High (II) operation

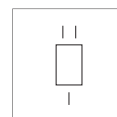

ZGS2

ZGS1 switch markings: Low (centre), AUX (I) & High (II) operation

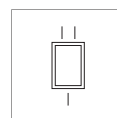

ZGS1

ZGRC1 boost and system status controller markings:  
Low (I) & High (II) operation



ZGRC1

(See section 3.1.8 for system status details)

**Note: Other manufacturers switches may show different markings, or your unit may be connected to a Building Management System (BMS).**

2.1.2 To maintain good indoor air quality within the dwelling it is important that the ventilation system remains in operation at all times unless powered down periodically for maintenance/repair.

2.1.3 **Warning:** This appliance can be used by children aged from 8 years and above and persons with reduced physical, sensory or mental capabilities or lack of experience and knowledge if they have been given supervision or instruction concerning use of the appliance in a safe way and understand the hazards involved. Children shall not play with the appliance. Cleaning and user maintenance shall not be made by children without supervision.

2.1.4 Where an open-flued oil or gas-fuelled appliance is installed, precautions must be taken to avoid a back-flow of gases into the room.

2.1.5 If the supply cord is damaged, it must be replaced by a special cord / assembly available from the manufacturer or its service agent (model code CAWMCM5C). The replacement must be carried out by a qualified Electrician in accordance with IEE or local regulations.

2.1.6 To disassemble the unit, disconnect from mains supply and use a screwdriver to segregate the electronic components and motors from the plastic housing. Dispose items in accordance with WEEE.

### 2.1.7 WEEE Statement

This product may not be treated as household waste. Instead it should be handed to an appropriate collection point for the recycling of electrical and electronic equipment.



**For more detailed information about the recycling of this product, please contact your local council office or your household waste disposal service.**

### 3.0 Controls

This section covers how to operate your ComfoAir Compact Heat Recovery unit.

#### 3.1 Overview of Integral LCD Display

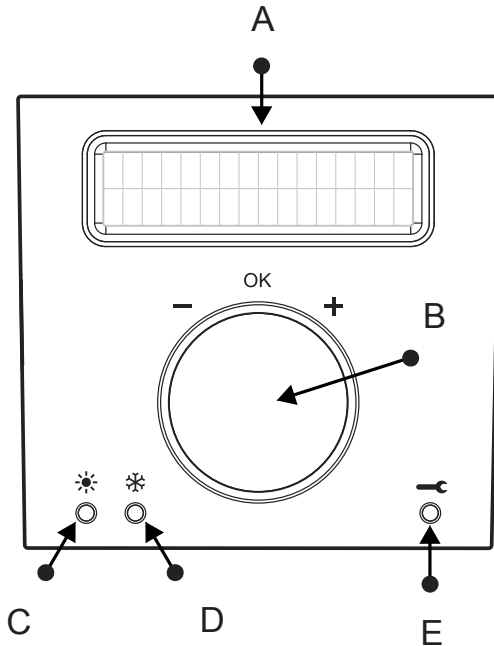

#	Meaning
A	Control Information Panel
B	Control Button
C	Summer ByPass LED
D	Frost Protection LED
E	Service/Fault LED

### USER / SERVICE / EXAMPLES MENU

Below are views / explanations of what you would see on your control panel.

**Example 1: Status / Service Log Screen**

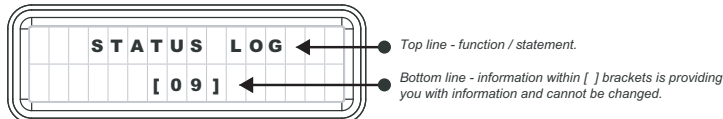

**Example 2: Function Selection Screen**

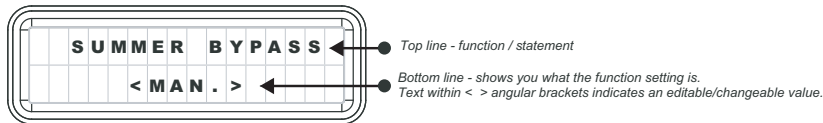

**Example 3: Warning / Alert Message**

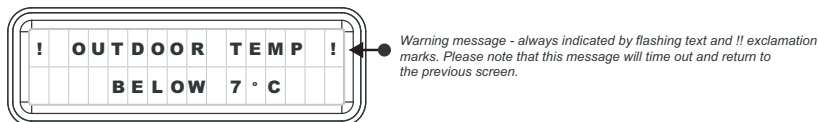

**Example 4: Status Message**

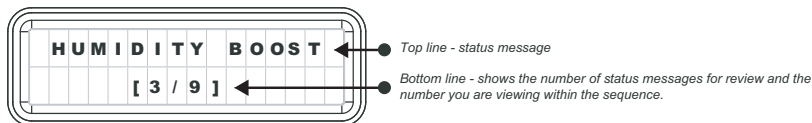

Note: For specific adjustment details, please refer to respective function shown on Pages 6 & 7.



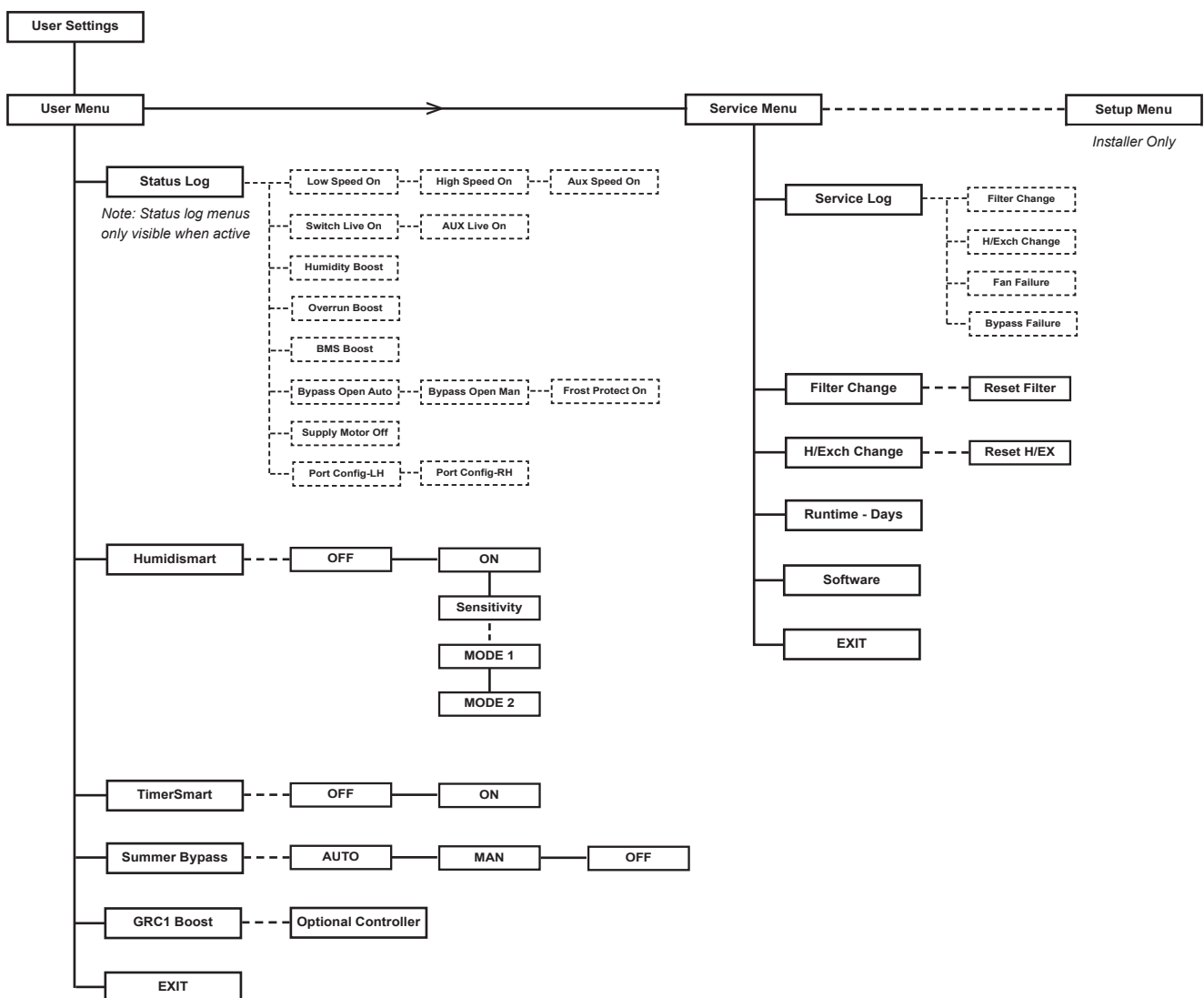

### 3.1.1 How to navigate through the unit menu

1. Lift cover on front of unit.
2. Press the 'Control Button' to activate the panel.
3. Rotate the button clockwise or anti-clockwise to required setting of either 'User Menu' or 'Service Menu' and press the button.
3. Scroll to the required option and press button.
4. The current setting status will flash.
5. Rotate button to desired outcome.
6. Press button to confirm.
7. Screen will time out after 30 seconds.

#### Steps of the User Menu



3.1.2

Function	Description
Smart Humidity 	Smart Humidity monitors the ambient humidity within the “wet” room environment and looks for short peaks of humidity made by either showering or bathing. This smart technology ensures that your ComfoAir 155 WM is not on boost for prolonged periods of time. (See 3.1.3 for adjust function setting On/Off ).
Smart Timer 	Smart Timer monitors the length of time that there has been an occupancy presence detected within a “wet” room (via the Switch Live) and provides a fixed over-run time period to best match the length of time that the Switch Live is active. (See 3.1.4 for adjust function setting On/Off ).
Smart Summer Bypass 	Smart Summer Bypass monitors the internal and external temperature and automatically identifies when the filtered summer bypass needs to be activated, protecting your home from overheating. (See 3.1.5 for adjust function setting Auto/Manual/Off).
Frost Protection 	Frost protection monitors the internal and external temperature and automatically identifies when the frost protection needs to be activated, protecting your unit from freezing.

3.1.3

**Smart Humidity**

To adjust the Smart Humidity Mode:

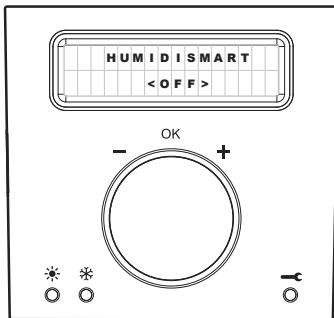

Factory set to ON  
Options ON / OFF

- Press control button to activate panel
- Scroll to “User Menu” option and press button to enter
- Scroll to “HumidiSmart” option and press button
- The current setting status will flash
- Rotate button to desired outcome
- Press to confirm
- Screen will time out after 30 seconds

**Note:**

You can adjust the sensitivity of your unit when Smart Humidity is ON. To adjust:

- Follow the steps above to 'HumidiSMART' option and select 'ON'
- Scroll right to the 'Sensitivity' option and press button
- The current setting status will flash
- Rotate button to desired outcome:
  - Mode 1 for standard setting (default)
  - Mode 2 for increased sensitivity
- Press to confirm
- Screen will time out after 30 seconds

3.1.4

**Smart Timer**

To adjust the Smart Timer Mode:

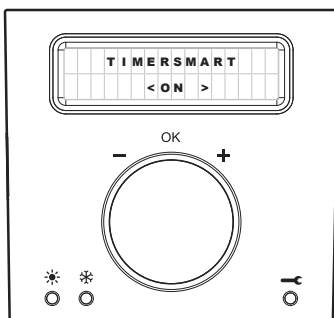

Factory set to ON  
Options ON / OFF

- Press control button to activate panel
- Scroll to “User Menu” option and press button to enter
- Scroll to “TimerSmart” option and press button
- The current setting status will flash
- Rotate button to desired outcome
- Press to confirm
- Screen will time out after 30 seconds

### 3.1.5 Smart Summer Bypass Manual Override

To manually override the Smart Summer Bypass Mode:

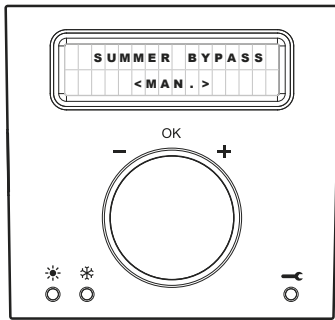

Factory set to AUTO  
Options AUTO / MAN / OFF

- Press control button to activate panel
- Scroll to "User Menu" option and press button to enter
- Scroll to "Summer Bypass" option and press button
- The current setting status will flash
- Rotate button to desired outcome
- Press to confirm
- Screen will time out after 30 seconds

**Note:**

- If "manual" option selected, the option will be available to "OPEN" or "SHUT" the summer bypass
- Rotate button to desired outcome and press to confirm
- Rotate button to select period of time required (0-96 hours, in 6 hour increments, note: 0 will return unit to auto mode)
- Press to confirm

**Note:**

**Unit will return to "Auto Mode" at the end of the manual time out period.  
Unit will not allow the Summer ByPass to be opened at temperature below 7°C.**

### 3.1.6 Ventilation Speed Control for ZGS2

The ZGS2 is a hard wired switch used to switch between Low and High speed

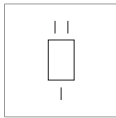

- Press the switch towards the (I) to activate the Low Speed
- Press the switch towards the (II) to activate the High Speed

### 3.1.7 Ventilation Speed Control for ZGS1

The ZGS1 is a hard wired switch used to switch between Low, AUX and High speed

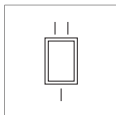

- Press to switch to the 'center' position to activate the Low Speed
- Press the switch towards the (I) to activate the AUX Speed
- Press the switch towards the (II) to activate the High Speed

**Note: AUX Speed may be set anywhere between 15%-100% airflow capacity. For set-up status please contact your installer for details.**

### 3.1.8 Ventilation Speed Control and System Status for ZGRC1

The ZGRC1 is a hardwired controller used to switch between low and high speeds as well as provide system status updates.

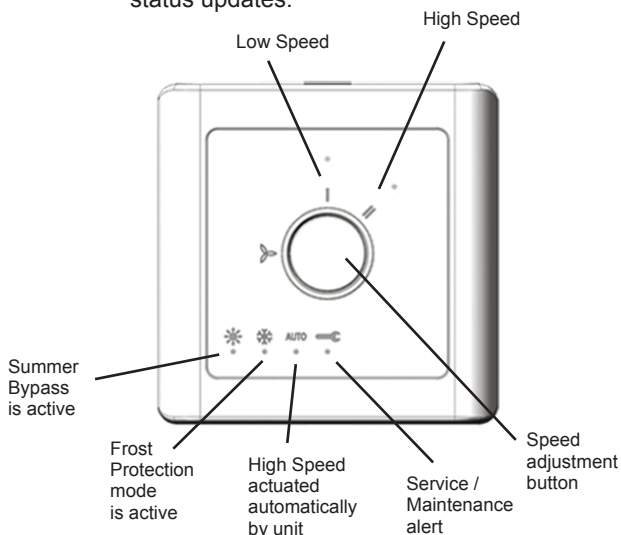

**To change speed setting**

- Press button to identify speed and system status
- Press button again to change speed

**Note:**

- Unit will automatically return to low speed.  
See LCD Control on ComfoAir 155 WM on page 8 for high speed time duration set up.

**ZGRC1 System Status Alerts**

- Status alerts are for indication only
- If Service / Maintenance is required please return to the ComfoAir 155 WM unit and follow guidelines in Section 4

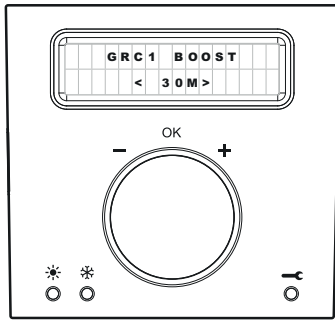

Factory default 30 mins  
Options 30, 60, 90 or 120 mins

#### LCD Control on ComfoAir 155 WM

- Press control button to activate panel
- Scroll to "User Menu" option and press button to enter
- Scroll to "GRC1 Boost" option and press button
- The current 'Boost' setting status will flash
- Rotate button to desired outcome (30, 60, 90 or 120 minutes)
- Press to confirm
- Screen will time out after 30 seconds

## 4.0 Servicing & Maintenance

Zehnder recommends a maintenance contract with a specialist ventilation maintenance company. Some installers provide a maintenance contract in which the user maintenance can be integrated. Contact the supplier of the unit for a list of registered installers nearby. The warranty becomes invalid if:

- \* Parts are used that have not been supplied by the manufacturer.
- \* The unit is used without filters.

### 4.1 **Warning: The units must be isolated from the Mains Supply before commencing any service or maintenance work.**

Part of system	Limit	Procedure
Valves	6 months	Clean the valves
Condensation drain	6 months	Fill the condensation drain
Filters	1 year	Replace the filters
Heat Exchanger	5 years	Clean the Heat Exchanger
Motor Impeller	5 years	Clean the Motor Impeller

4.1.1 Your ComfoAir 155 WM unit contains forward curved impellers that require cleaning every 5 years, it is recommended that this is carried out at the same time as the Heat Exchanger cleaning.

**Note: The motors have sealed for life bearings, which do not require lubrication.**

Periodic cleaning of the ceiling supply and extract valves should be carried out as required, taking care not to adjust the valves set position, as this may cause an unbalanced system, resulting in either under-ventilation or unnecessary over-ventilation occurring. (See Section 4.2.1)

Periodic inspection and/or replacement of filters should be carried out. Frequency greatly depends on geographic location and urban density. The filters trap dirt in the atmosphere and act as protection for both the system and the dwelling. The system's airflow can be reduced if the filters are not replaced, this can affect overall system performance. For this reason, it is important to check the filters regularly and to replace them as often as each year (See Section 4.1.9).

Periodic inspection and/or cleaning of the heat exchanger should be carried out. The filters should help to protect the heat exchanger but over time, dirt in the atmosphere can penetrate the filters and gain access to the heat exchanger. The system's airflow can be reduced if the heat exchanger is not cleaned and this can affect overall system performance. For this reason, it is important to check the status of the heat exchanger regarding the time remaining indicated on the display (See Sections 4.1.10).

The condensation drain is connected to the domestic waste-water system. To prevent sewer smells from entering your home, the water seal of the domestic waste-water system must always contain water. You can achieve this by pouring a cup of water into the water seal.

4.1.2 **Spare Parts.** Please contact us for replacement filters. A range of spare parts are available, contact us for details, quoting the serial number and product name of the unit which can be found on the underside of the unit controller cover as shown in 4.1.4 on page 9.



#### 4.1.3 Service Indicator

If the filters need replacing or the heat exchanger requires cleaning, the LED with the Service symbol  will appear. To establish what needs to be replaced/cleaned, you will need to access the Service Menu and review the Service Log. Complete required actions and note the details on the Service & Maintenance Log located on page 13.

#### 4.1.4 Service Log

This enables you to identify what your system requires, to review the Service Log:

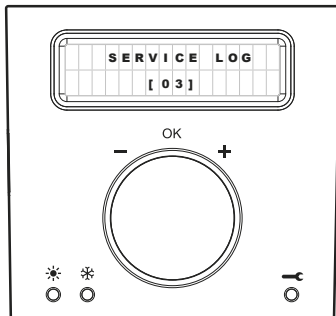

- Press control button to activate panel
- Scroll to “Service Menu” option and press button to enter
- First option is the “Service Log” which indicates the number of logs for review, press button to enter
- Scroll through each log and press button to return back to main options within the Service Menu

**NOTE: If "fan failure" log is showing please contact us or your installer and quote your serial number which can be found on the underside of the unit controller cover.**

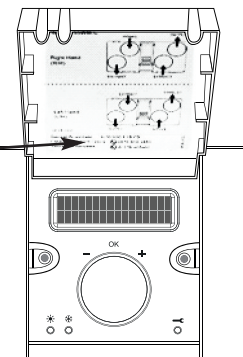

#### 4.1.5 Filter Status

If the Filter status within the “Service Log” is showing as 0 days the filters will need to be replaced (See Section 4.1.9).

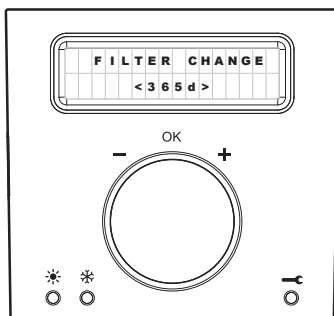

- Press control button to activate panel
- Scroll to “Service Menu” option and press button to enter
- First option is the “Service Log” which indicates the number of logs for review
- Scroll to “Filter Change” option and press button
- The request to reset timer will flash
- Press to confirm
- Screen will time out after 30 seconds
- Note details on the Service & Maintenance Log on page 13

#### 4.1.6 Heat Exchanger Status

If the Heat Exchanger status within the “Service Log” is showing as 0 weeks the heat exchanger will need to be cleaned (See Section 4.1.10).

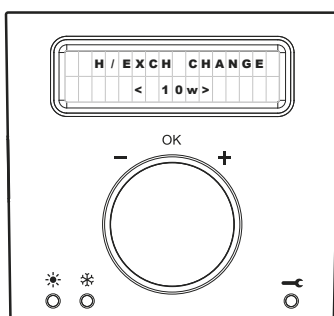

- Press control button to activate panel
- Scroll to “Service Menu” option and press button to enter
- First option is the “Service Log” which indicates the number of logs for review
- Scroll to “H/Exch Change” option and press button
- The request to reset timer will flash
- Press to confirm
- Screen will time out after 30 seconds
- Note details on the Service & Maintenance Log on page 13

#### 4.1.7 Run Time

To review the length of time your unit has been in operation:

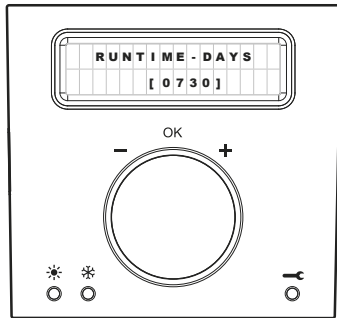

- Press control button to activate panel
- Scroll to "Service Menu" option and press button to enter
- Scroll to "Runtime - Days" option to review (time shown in days)
- Screen will time out after 30 seconds

#### 4.1.8 Software Identification

To review what software version is activated on your unit:

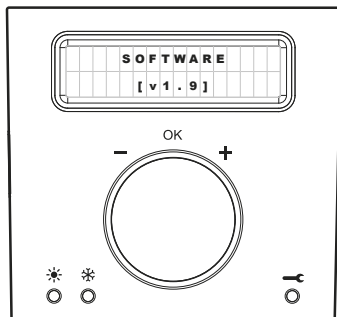

- Press control button to activate panel
- Scroll to "Service Menu" option and press button to enter
- Scroll to "Software" option to review
- Screen will time out after 30 seconds

#### 4.1.9 To replace the Filters

- Replace at approximately 1 year interval.

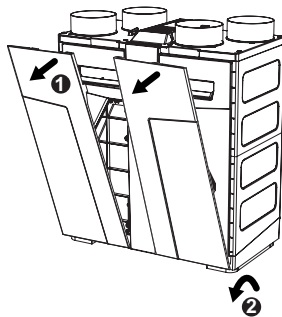

**Step 1** Isolate the unit from the Mains Supply. Pull down the top part (❶) of the two front panels and lift out (❷) of locating tabs at the bottom.

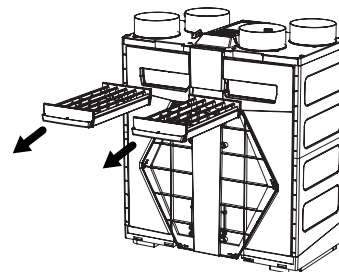

**Step 2** Remove both filters from the unit by the handles.

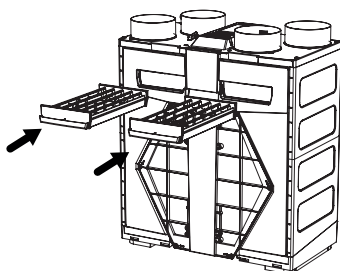

**Step 3** Re-insert new filters into the unit.

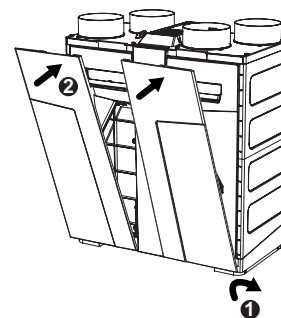

**Step 4** Locate the front panels in the bottom tabs (❶) and click them back into place at the top (❷). Turn the Mains Supply back on. Reset Filter Status (See Section 4.1.5). Note details on the Service & Maintenance Log on page 13.

#### 4.1.10 To Clean the Heat Exchanger and Motor Impeller

- Clean approximately at five year intervals.

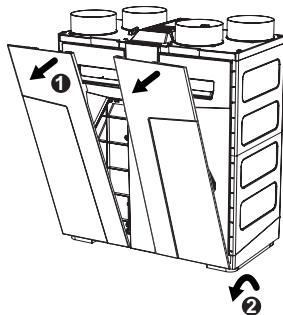

**Step 1** Isolate the unit from the Mains Supply. Pull down the top part (1) of the two front panels and lift out (2) of locating tabs at the bottom.

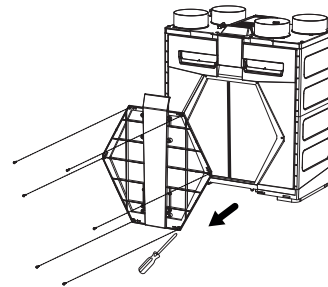

**Step 2** Unscrew the six heat exchanger locating screws and remove panel.

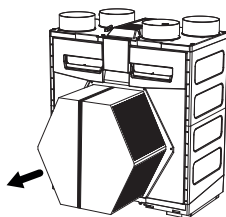

**Step 3** Remove the heat exchanger by gently pulling on the nylon strap, taking care not to damage it. Clean each face of the heat exchanger with a vacuum cleaner and wash with warm water. Gently clean the motor impellers on both sides of the unit by using a brush. Ensure heat exchanger is dry before continuing to Step 4.

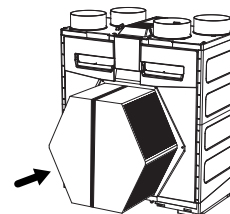

**Step 4** Re-insert the cleaned heat exchanger, taking care not to cause damage.

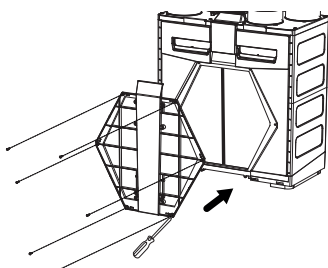

**Step 5** Reposition the panel and secure with the six locating screws.

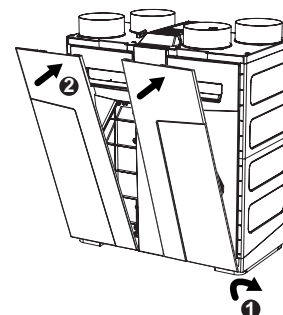

**Step 6** Locate the front panels in the bottom tabs (1) and click them back into place at the top (2). Turn the Mains Supply back on. Reset Heat Exchanger Status (See Section 4.1.6). Note details on the Service & Maintenance Log on page 13.

**Important Note: Do not attempt to clean the heat exchanger with detergent.**

4.2.0

**Access for Maintenance**

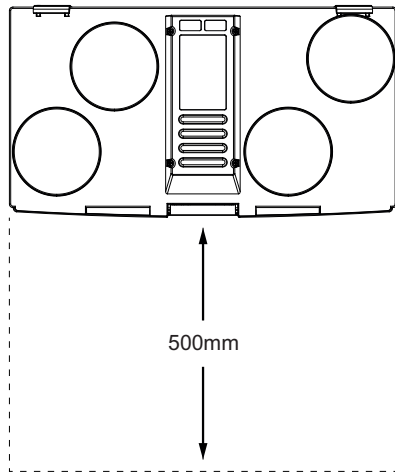

TopView

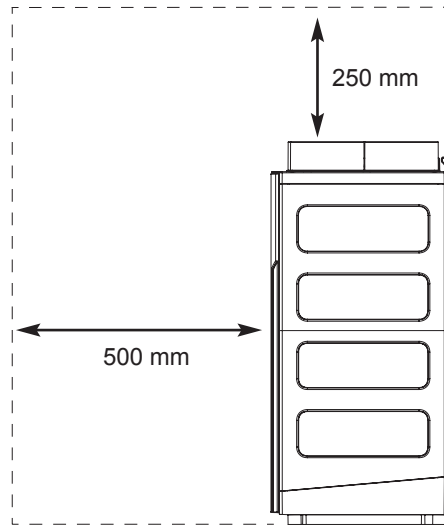

Side View

4.2.1

**To clean the valves**

- Clean any valve present in your home at least every six months.

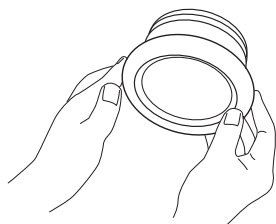

**Step 1** Keep hold of the valve on its outer edge and pull it completely out of the wall or ceiling with a rotating movement. If a rubber ring is fitted: Take care when removing the valve to leave the rubber ring in place.

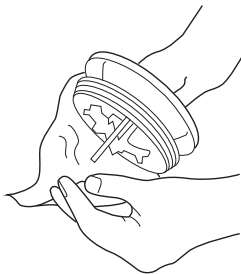

**Step 2** Mark the location and setting of the valve.

- Do not change the settings of the valve as it would negatively influence the system performance.
- Do not swap the valves with one another as it will negatively influence the system performance.

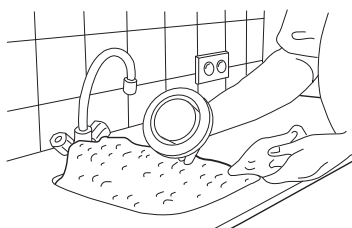

**Step 3** Remove the filter behind the valve (if present).

**Step 4** Clean the valve with a soft brush, vacuum cleaner or soapy water. Rinse the valve and then dry.

**Step 5** Replace the filter behind the valve (if present).

**Step 6** Place the valve back in the wall or ceiling. Note details on the Service & Maintenance Log on page 13.

**Supply valve ComfoValve Luna S125**

The ComfoValve Luna S125 supply valve is equipped with a detachable design cover. Therefore this valve can stay in the wall or ceiling during cleaning.

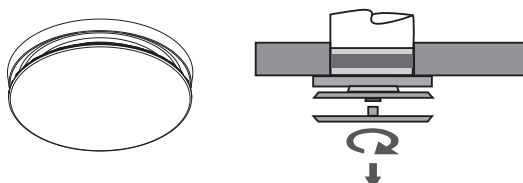

Turn the design cover a quarter **counterclockwise** and then remove it from the valve.





## 5.0 Commissioning & Inspection Record

5.1 This section should be used to record all installation details. The Commissioning Engineer should use the following Parts 1 to 3, to record important information relating to the installation, of which, copies should be given to the Building Control Body (BCB), the Developer, the installer and also be incorporated into the Homeowner Pack for the homeowner to keep.

•	Part 1	System details and declarations
•	Part 2a	Installation details
•	Part 2b	Inspection of installation
•	Part 3	Airflow measurement test and commissioning details

### Part 1 - System details and declaration

1.1 Installation Address Details	
Dwelling Name / Number	
Street	
Locality	
Town	
Country	
Post Code	

1.2 Installation Details	
System Classification*	System 4 - Continuous Mechanical Supply and Extract with Heat Recovery
Manufacturer	Zehnder Group UK Limited
Model Number	
Serial Number (where available)	
Location of MVHR Unit	

**\*Note: If a system has been installed that is not defined by System 1 to 4 in Approved Document F, further installation checks and commissioning procedures may be required. Seek particular guidance from the manufacturer for these systems.**

### Part 2a - Installation

1.1 Installation Checklist - General (all Systems)		Tick as appropriate	
Has the system been installed in accordance with manufacturer's instructions?	Yes	No	
Have relevant system installation clauses been followed as detailed in Tables 1, 3, 5 and 7 as applicable?	Yes	No	
Type of ductwork installed (e.g. rigid, semi-rigid)			
If any deviation from Tables 1,3, 5 and 7, these should be detailed here.			
Description of installed controls (e.g. timer, central control, humidistat, PIR, etc.			
Location of manual / override controls			

## 2.2 Installation Engineer's Details

Name	
Company	
Address Line 1	
Address Line 2	
Telephone Number	
Post Code	
Signature	
Competent Person Scheme / Registration Number (if applicable)	
Date of Installation (completion)	

## Part 2b - Inspection of Installation

This section should be completed before completing Part 3

### 2.3a Visual Inspections - General (all Systems)

Tick as appropriate

	Tick as appropriate	
Total installed equivalent area of background ventilators in dwelling?		mm
Total floor area of dwelling?		m <sup>2</sup>
Does the total installed equivalent ventilator area meet the requirements given in Tables 5.2a, 5.2b, or 5.2c in ADF?	Yes	No
Have all background ventilators been left in their open position?	Yes	No
Have the correct number and location of extract fans / terminals been installed that satisfy Table 5.2a in ADF?	Yes	No
Is the installation complete with no obvious defects present	Yes	No
Do all internal doors have sufficient undercut to allow air transfer between rooms i.e. 10mm over and above final floor finish)?	Yes	No
Has all protection / packaging been removed (including from background ventilators) such that system is fully functional?	Yes	No
For ducted systems, has the ductwork installation been installed in such a manner that air resistance and leakage is kept to a minimum?	Yes	No
Are the correct number and size of background ventilators provided that satisfy ADF?	Yes	No
Has the entire system been installed such that there is sufficient access for routine maintenance and repair / replacement of components?	Yes	No

### 2.3b Visual Inspections - General (Systems 3 and 4 only)

Tick as appropriate

Have appropriate air terminal devices been installed to allow system balance?	Yes	No
Has the heat recovery unit (System 4 only) and all ductwork been effectively insulated where installed in unheated spaces?	Yes	No
Condensate connection is complete and drains to an appropriate location (System 4 only)	Yes	No



### 2.3c Other Inspections - General (Systems 1,3 and 4 only)

Upon initial start up, was any abnormal sound or vibration experienced, or unusual smells detected?	Yes	No
---	-----	----

### 2.3d Inspector's Details

Name	
Company	
Address Line 1	
Address Line 2	
Telephone Number	
Post Code	
Signature	
Competent Person Scheme / Registration Number (if applicable)	
Date of Inspection (completion)	

## Part 3 - Airflow measurement test and commissioning details

### 2.3c Other Inspections - General (Systems 1,3 and 4 only)

Schedule of air flow measurement equipment used, (model and serial)	Date of last UKAS calibration
1.	
2.	
3.	

### 3.3 Air Flow Measurements (Extract) - (Systems 3 and 4 only)

Room reference (location of terminals)	Measured Air Flow High Rate (l/s)	Design Air Flow High Rate (l/s) Refer to Table 5.1a in ADF	Measured Air Flow Low Rate (l/s)	Design Air Flow Low Rate (l/s) Refer to Table 5.1a in ADF	(If applicable) Measured Air Flow AUX Rate (l/s)
Kitchen					
Bathroom					
En Suite					
Utility					
Other ...					
Other ...					
Other ...					

### 3.4 Air Flow Measurements (supply) - Systems 4 only

Room reference (location of terminals)	Measured Air Flow High Rate (l/s)	Design Air Flow High Rate (l/s) Refer to Table 5.1b in ADF	Measured Air Flow Low Rate (l/s)	Design Air Flow Low Rate (l/s) Refer to Table 5.1b in ADF	(If applicable) Measured Air Flow AUX Rate (l/s)
Living Room 1					
Living Room 2 (if present)					
Dining Room					
Bedroom 1					
Bedroom 2					
Bedroom 3					
Bedroom 4					
Bedroom 5					
Other ...					

### 3.5 Commissioning (Systems 3 and 4 only)

Have controls been set-up in accordance with the manufacturer's recommendations?	Yes	No
Have all distribution grilles been locked to prevent unauthorised adjustment?	Yes	No

### 3.6 Test Engineer's Details

Name	
Company	
Address Line 1	
Address Line 2	
Telephone Number	
Post Code	
Signature	
Competent Person Scheme / Registration Number (if applicable)	
Date of Test	



## 6.0 The Guarantee Period

- 6.1 This Zehnder ComfoAir 155 WM has a 2 Year Guarantee as standard with the option to extend to a 6 Year Guarantee, subject to registration. Terms and conditions apply.
- 6.1.1 This does not affect your statutory rights.
- 6.1.2 Full details available at [www.zehnder.co.uk](http://www.zehnder.co.uk)

All information is believed correct at time of going to press. E&OE.

All goods are sold according to Zehnder's Standard Conditions of Sale which are available on request. All dimensions referred to are in millimetres unless otherwise stated.

Zehnder Group International Sales reserves the right to change specifications and prices without prior notice.

© Copyright Zehnder Group 2019

### Zehnder Group UK Limited

Watchmoor Point, Camberley,  
Surrey, GU15 3AD

Customer Services: +44 (0) 1276 408404  
Technical Services: +44 (0) 1276 408402  
Email: [info@zehnder.co.uk](mailto:info@zehnder.co.uk)  
Web: [www.zehnder.co.uk](http://www.zehnder.co.uk)

